

CD RECEIVER

KDC-MP828 KDC-W7531/Y KDC-W8531/Y KDC-X789/X8529/X889 SERVICE MANUAL

KENWOOD

Kenwood Corporation

© 2005-3 PRINTED IN JAPAN
B53-0265-00 (N) 1708

A unique identification number (Unique ID) is given to each unit, which is imprinted on the CD mechanism assembly. If and when the mechanism assembly or Flash ROM (IC17) on the mechanism board is replaced, it is necessary to write the Unique ID. For details, refer to "How to Write the Unique ID" on Page 18.

CD MECHANISM EXTENSION
CORD (24P) : **W05-0934-00**

KDC-MP828

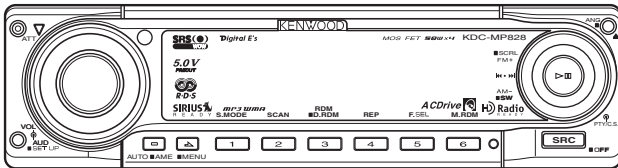

KDC-W7531/Y

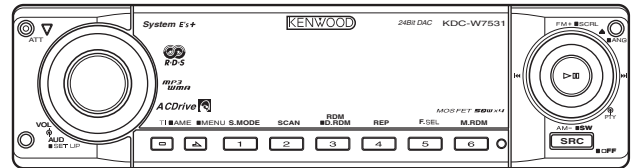

KDC-W8531/Y

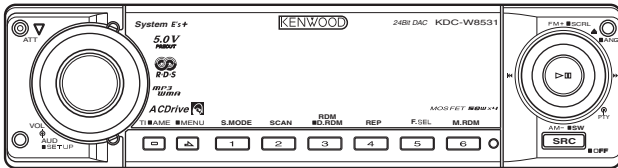

KDC-X789

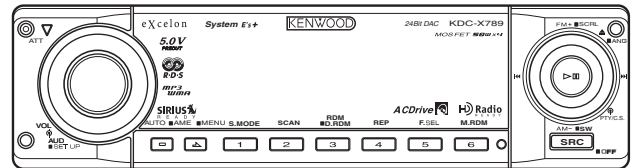

KDC-X8529

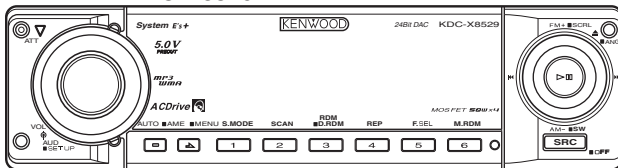

KDC-X889

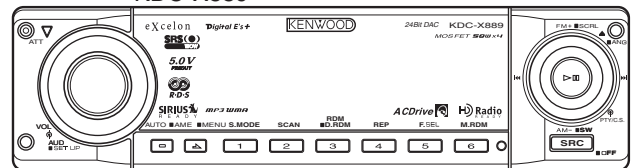

Mounting hardware assy
(J21-9716-03)

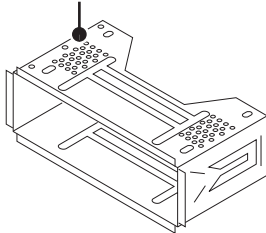

Plastic cabinet assy
(A02-2732-03)

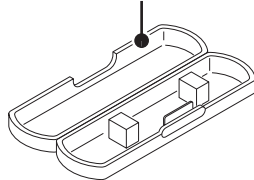

SPARE TDF PANEL

MAIN UNIT NAME	TDF PARTS No.	TDF NAME
KDC-MP828	Y33-2200-61	TDF-MP85D
KDC-W7531/Y	Y33-2190-64	TDF-W7531
KDC-W8531/Y	Y33-2190-63	TDF-W8531
KDC-X789	Y33-2190-61	TDF-75DX
KDC-X8529	Y33-2190-62	TDF-X8529
KDC-X889	Y33-2190-60	TDF-85DX

* DC cord
(E30-xxxx-xx)

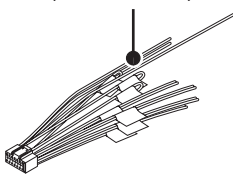

* Escutcheon
(B07-xxxx-xx)

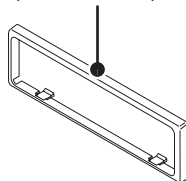

* Compact disc
(W01-xxxx-xx)

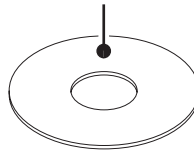

* Screw set
(N99-xxxx-xx)

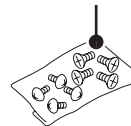

* Remote controller assy (RC-527)
(A70-2067-05)

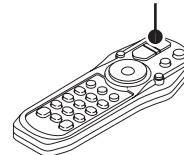

Battery
(Not supplied)

* DC cord
(E30-6412-05)

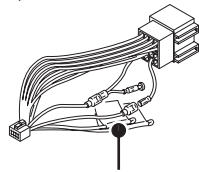

* Antenna adaptor
(T90-0523-05)



Lever
(D10-4589-04) x2

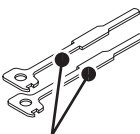

* Tapping screw
(N09-xxxx-xx)



* Depends on the model. Refer to the parts list.

This product uses Lead Free solder.



BLOCK DIAGRAM

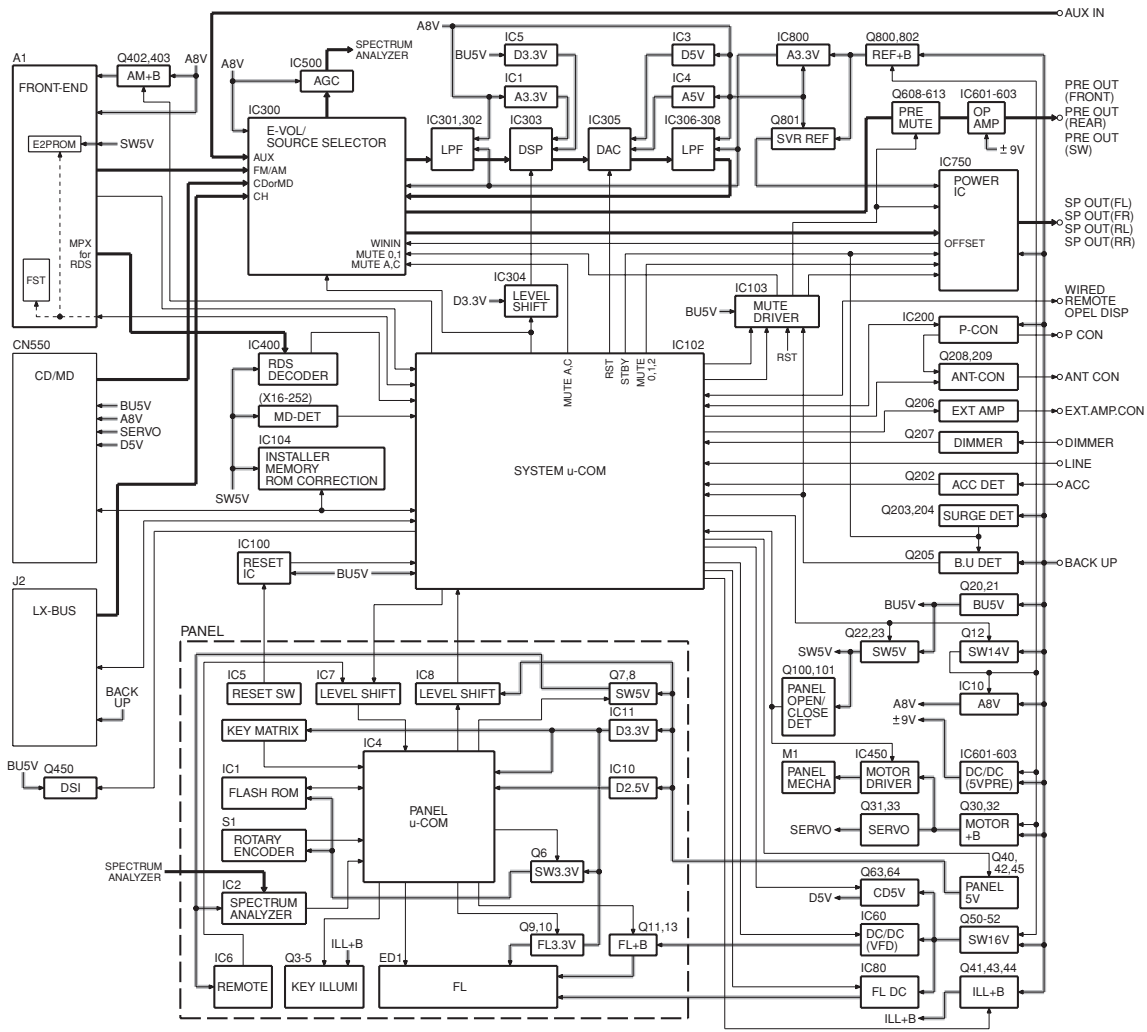

CD PLAYER UNIT (X32-5730)

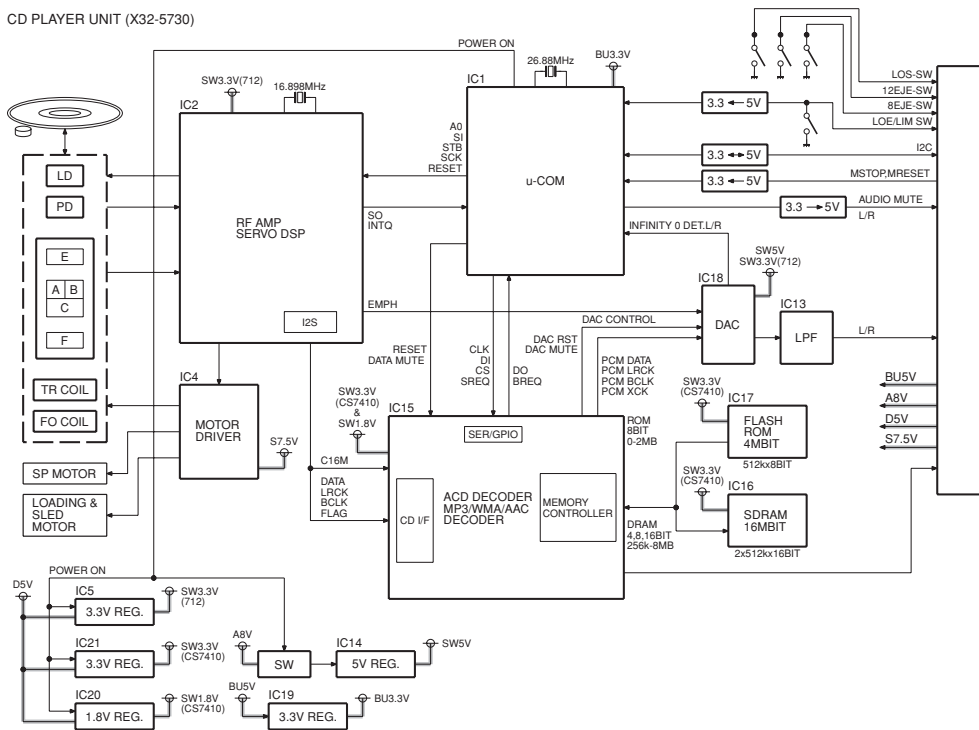

COMPONENTS DESCRIPTION

● ELECTRIC UNIT (X34-3xxx-xx)

Ref. No.	Application / Function	Operation / Condition															
IC1	DSP ANALOG POWER SUPPLY	3.3V output															
IC3	DAC DIGITAL POWER SUPPLY	5.0V output															
IC4	DAC ANALOG POWER SUPPLY	5.0V output															
IC5	DSP DIGITAL POWER SUPPLY	3.3V output															
IC10	AUDIO8V REF POWER SUPPLY	1.27V output															
IC60	SWITCHING REGULATOR CONTROLLER	VFD / Mechanism digital power supply. OUT1 : VFD (4.7V), OUT2 : Mechanism digital (5V)															
IC80	FL+B	VFD power supply (57V)															
IC100	RESET IC	"L" when detection voltage is 3.6V or less															
IC102	SYSTEM μ -COM	FM/AM tuner / Changer / CD mechanism / Panel / Volume / Tone control															
IC103	MUTE DRIVER	Mute control															
IC104	E2PROM	Installer memory															
IC200	POWER CONTROL IC	Power control switching															
IC300	E-VOL & SOURCE SELECTOR	Source / Volume / Tone control															
IC301,302	AUDIO BUFFER AMP	DSP input LPF															
IC303	DSP	Digital signal processing															
IC304	LEVEL SHIFT	Conversion from 3.3V to 5.0V															
IC305	DAC	D/A Converter															
IC306~308	AUDIO BUFFER AMP	DAC output LPF															
IC400	RDS DECODER																
IC450	PANEL MECHA MOTOR DRIVER	<table border="1"> <thead> <tr> <th>IN1</th> <th>IN2</th> <th>PANEL MECHA</th> </tr> </thead> <tbody> <tr> <td>L</td> <td>L</td> <td>WAIT</td> </tr> <tr> <td>L</td> <td>H</td> <td>OPEN</td> </tr> <tr> <td>H</td> <td>L</td> <td>CLOSE</td> </tr> <tr> <td>H</td> <td>H</td> <td>STOP</td> </tr> </tbody> </table>	IN1	IN2	PANEL MECHA	L	L	WAIT	L	H	OPEN	H	L	CLOSE	H	H	STOP
IN1	IN2	PANEL MECHA															
L	L	WAIT															
L	H	OPEN															
H	L	CLOSE															
H	H	STOP															
IC451	G-ANALYZER	Analog gravity sensor															
IC500	SPECTRUM ANALYZER BUFFER AMP & AGC	Spectrum analyzer buffer / Auto gain control															
IC600	\pm 9V AVR	5V pre-out power supply															
IC601~603	5V PREOUT AMP	Buffer/Gained control															
IC750	POWER IC	Front L/R and a rear L/R signal amplification															
IC800	AUDIO3.3V REF SUPPLY / SVR6.8V REF SUPPLY	Supplying audio 3.3V reference voltage to E-VOL/LPF Supplying SVR6.8V reference voltage to IC750 (POWER IC)															
Q10,11	AUDIO8V AVR	When Q11 base is "H", A8V is output															
Q12	SW14V	When base is "H", SW14V is output															
Q20,21	B.U.5V AVR	When backup is "ON", BU5V is output															
Q22,23	SW5V	When Q23 base is "H", SW5V is output															
Q30,32	MOTOR+B AVR (PANEL MECHA)	When Q9 base is "H", 7.5V MOTOR+B is output															
Q31,33	SERVO+B AVR	When Q33 base is "H", 8V SERVO+B is output															
Q40,42,45	PANEL5V AVR	When Q42 base is "H", PANEL5V is output															
Q41,43,44	ILLUMINATION AVR	When Q43 base is "H", 10.5V ILLUMI voltage is output															
Q50~52	SW16W (SERGE PROTECTION)	When Q51 base is "H", SW16V (13V) is output															

COMPONENTS DESCRIPTION

Ref. No.	Application / Function	Operation / Condition															
Q60	VFD (4.7V) AVR SW	When base is "H", VFD AVR is turned "OFF"															
Q61	SWITCHING REGULATOR FREQUENCY CONTROL SW (IC60)	<table border="1"> <thead> <tr> <th colspan="2"></th> <th colspan="2">F SEL2 (BASE)</th> </tr> <tr> <th colspan="2"></th> <th>L</th> <th>H</th> </tr> </thead> <tbody> <tr> <th rowspan="2">F SEL1 (BASE)</th> <th>L</th> <td>400kHz</td> <td>600kHz</td> </tr> <tr> <th>H</th> <td>650kHz</td> <td>850kHz</td> </tr> </tbody> </table>			F SEL2 (BASE)				L	H	F SEL1 (BASE)	L	400kHz	600kHz	H	650kHz	850kHz
		F SEL2 (BASE)															
		L	H														
F SEL1 (BASE)	L	400kHz	600kHz														
	H	650kHz	850kHz														
Q62	MECHA DIGITAL AVR SW	When base is "H", MECHA DIGITAL AVR is turned "OFF"															
Q63	VFD (4.7V) AVR SWITCHING POWER DRIVER	Controlled by IC60 and Q61 determines frequency															
Q64	MECHA DIGITAL AVR POWER DRIVER	Controlled by IC60 (Frequency is fixed to 400kHz)															
Q80,81	VFD (57V) AVR SW	When Q81 base is "H", VFD (57V) is output															
Q91	PANEL5V DISCHARGE SW	When base is "H", PANEL5V is discharged															
Q100,101	PANEL DETECT SW	When Q100 base is "L", panel is detected															
Q200,201	PREOUT MUTE DRIVER	When base is "L", MUTE DRIVER is turned "ON"															
Q202	ACC DETECT SW	When base is "H", ACC voltage is detected															
Q203,204	SERGE DETECT SW	When Q204 base is "H", IC750 (POWER IC) is turned to standby.															
Q205	BU DETECT SW	When Q35 base is "H", backup voltage is detected															
Q206	EXT AMP CONTROL BUFFER	Output buffer from IC102 (μ -COM)															
Q207	SMALL LAMP DETECT SW	When base is "H", small lamp is detected															
Q208,209	POWER ANTENNA SW	Q206 base is "H", 14V POWER ANTENNA voltage is output															
Q300	DSP MUTE SW	When base is "L", DSP is muted															
Q402,403	AM+B SW	When Q403 base is "H", AM+B is output															
Q450	DSI DRIVER	When base is "H", DSI is turned "ON". When base is "L", DSI is turned "OFF". When panel is off, DSI blinks.															
Q500	SPECTRUM ANALYZER AGC CONTROLLER	When excess input is made, feed-back is interrupted which slows down output.															
Q600~602	PRE-AMP +9V AVR	Q600 and Q602 function as differential amplifier. Q601 functions as a driver and +9.4V is supplied to op amp for pre-out.															
Q603~605	PRE-AMP -9V AVR	Q603 and Q605 function as differential amplifier. Q604 functions as a driver and -9.1V is supplied to op amp for pre-out.															
Q606,607	AUDIO 10.5V AVR	When Q606 base is "H", 10.5V is output															
Q608~613	PREOUT MUTE SW	When base is "H", pre-out is muted															
Q800,802	REF+B AVR	When Q800 base is "H", 13V is output															
Q801	SVR6.8V REF SUPPLY AGC CONTROLLER	When backup voltage is down, feed-back is interrupted which slows down output.															

● SWITCH UNIT (X16-2950-1x / X16-3122-71)

Ref. No.	Application / Function	Operation / Condition
IC1	ROM IC / FLASH ROM IC	Display image data storage
IC2	SPECTRUM ANALYZER	6-ch band pass filter
IC4	PANEL μ -COM	
IC5	RESET IC	Functions when panel is attached
IC6	REMOTE CONTROL	
IC7	LEVEL SHIFT	Conversion from 5V level to 3.3V
IC8	LEVEL SHIFT	Conversion from 3.3V level to 5V

COMPONENTS DESCRIPTION

Ref. No.	Application / Function	Operation / Condition
IC9	BUFFER	Functions when controlling fluorescent indicator tube (ED1)
IC10	2.5V REGULATOR	For 2.5V power supply
IC11	3.3V REGULATOR	For 3.3V power supply
Q1	TRIANGLE GREEN LED SW	Lights up when base is "H"
Q2	TRIANGLE RED LED SW	Lights up when base is "H"
Q3	BLUE LED SW	Lights up when base is "H"
Q4	GREEN LED SW	Lights up when base is "H"
Q5	RED LED SW	Lights up when base is "H"
Q6	SW3.3V SW	When base is "L", SW3.3V is supplied to IC1 and IC3
Q7,8	SW5V SW	When Q8 base is "H", SW5V is supplied to IC2 and IC6
Q9,10	FL3.3V SW	When Q9 base is "H", FL+3.3V (VDD1) is supplied to fluorescent indicator tube
Q12	FL BLK SW	When base is "H", fluorescent indicator tube (ED1) lights up
Q11,13	FL+B SW	When Q11 base is "H", FL+B (VDD2) is supplied to fluorescent indicator tube

● CD PLAYER UNIT (X32-5730-00)

Ref. No.	Application / Function	Operation / Condition
IC1	μ-com for mechanism control	
IC2	LSI for CD signal processing +RF AMP	
IC4	BTL driver	SP, SL (including LO/EJ) motor and PU actuator
IC5	SW3.3V regulator	3.3V power supply for IC2, PU, and IC18 digital section
IC13	Audio active filter	Secondary LPF
IC14	A5V regulator	5V power supply for DAC
IC15	Compacted audio decoding DSP	AC drive decoder, MP3/WMA/AAC decoder
IC16	Compacted audio expanding SDRAM	
IC17	Decoder software, unique ID storage flash ROM	
IC18	Audio external 24-bit D-A converter	
IC19	BU3.3V regulator	3.3V power supply for μ-com
IC20	1.8V regulator	1.8V power supply for core section of IC15
IC21	Decoder/SDRAM/Flash ROM 3.3V regulator	3.3V power supply for port section of IC15, IC16 and IC17
Q1,4	Level shift (3.3V~5V) FET	
Q3,5,6	Level shift (3.3V~5V) transistor with 2 elements	
Q7	Level shift (3.3V~5V) transistor	
Q8	APC (Auto Power Control) transistor	
Q9,10	Transistor for preceding beam delaying SW during non-search	
Q11	A5V power supply constant circuit FET	
Q12,13	SW8V SW transistor	
Q14,15	SDRAM 3.3V power supply SW transistor	SDRAM power supply is turned off when /CSRST is "L"
D2	UPD63712GC built-in resetting terminal static protection diode	
D3	Protection diode for pick-up laser diode	
D4,D5	Diode for securing audio L-R reference voltage	
D6	Diode for control terminal's "L" confirmation for IC20 and IC21	

MICROCOMPUTER'S TERMINAL DESCRIPTION

● SYSTEM MICROCOMPUTER : IC102 (X34- : ELECTRIC UNIT)

Pin No.	Pin Name	I/O	Function	Processing Operation
1	VREF	-	Analog reference voltage	
2	AVCC	-		
3	LX DATA S	I	Data from slave unit	
4	LX DATA M	O	Data to slave unit	
5	LX CLK	I/O	LX-BUS clock	
6	WIRED REMO	I	External display remoter controller	
7	LX MUTE	I	Mute request from slave unit	H : MUTE ON, L : MUTE OFF
8	AUD SDA	O	E-VOL data	SPI communication
9	AUD SEL	O	E-VOL control	SPI communication
10	AUD SCL	O	E-VOL clock	SPI communication
11	$\overline{\text{DAC RST}}$	O	DAC reset	L : DAC RESET
12	NC	-	Not used	
13	BYTE	-	GND	
14	CNVSS	-		
15	XCIN	I	Clock	32,768kHz
16	XCOU	I	Clock	32,768kHz
17	$\overline{\text{RESET}}$	I	Reset	
18	XOUT	-	Clock	12MHz
19	VSS	-	GND	
20	XIN	-	Clock	12MHz
21	VCC1	-		
22	NMI	I		
23	PANEL DET	I	Panel detection	H : No panel, L : Panel exists
24	RDS CLK	I	RDS decoder clock	
25	LX REQ S	I	Communication request from slave unit	
26	PON AM	I/O	AM power supply control	AM in operation : H, AM not in operation : HI-Z
27	LX REQ M	O	Communication request to slave unit	
28	TUN IFC OUT	I	Front-end IFC out	H : Station exists, L : No station
29	RDS AFS L	I/O	Time constant switching when noise detected	Refer to Truth Value Table (RDS AFS)
30	RDS AFS M	I/O	Time constant switching when noise detected	Refer to Truth Value Table (RDS AFS)
31	RDS QUAL	I	RDS decoder QUAL	
32	RDS DATA	I	RDS decoder DATA	
33	PWIC BEEP	O	Beep	
34	TUN SCL	I/O	Front-end I2C clock	MAX 400kHz
35	TUN SDA	I/O	Front-end I2C data	
36	SYS DATA	O	Inside-panel communication data	MAX 500kbps
37	VCC1	-		
38	PAN DATA	I	Inside-panel communication data	MAX 500kbps
39	VSS	-		
40	SYS REQ	O	Communication request from system μ -com	
41	PAN REQ	I	Communication request from panel	
42	SDA	I/O	E2PROM I2C data	MAX 100kHz

MICROCOMPUTER'S TERMINAL DESCRIPTION

Pin No.	Pin Name	I/O	Function	Processing Operation
43	SCL	I/O	E2PROM I2C clock	MAX 100kHz
44	PON PANEL	I/O	Panel 5V control	ON : H (Momentary power down/Panel detached) 11 Minutes after ACC OFF : Hi-Z
45	DSI	I/O	DSI control	
46~49	NC	-	Not used.	
50	PM MOT1	O	Panel motor control 1	Refer to Truth Value Table (PANEL MOTOR)
51	PM MOT2	O	Panel motor control 2	Refer to Truth Value Table (PANEL MOTOR)
52	EPM	I	Flash EPM	
53	PM OPEN	I	Panel full open detection	Refer to Truth Value Table (PANEL MECHA)
54~56	NC	-	Not used	
57	P5V DIS	I/O	Panel 5V discharge control	H : Discharge, Other : Hi-Z
58	PM CLOSE	I	Panel mechanism close detection	Refer to Truth Value Table (PANEL MECHA)
59	ROMCOR DET	I	E2PROM write request	H : Write
60	PM DET	I	Panel mechanism detection	H : Function check in progress
61	SC CON	O	Inside-panel communication (Chip enable when flash)	POWER OFF, ACC OFF : L
62	NC	-	Not used	
63	TUN TYPE1	I	Destination setting 1	TUN TYPE1 : L, TUN TYPE2 : L
64	TUN TYPE2	I	Destination setting 2	TUN TYPE1 : L, TUN TYPE2 : L
65,66	NC	-	Not used	
67	CD DISC12 SW	I	12cm CD detection	
68	CD LOS SW	I	CD loading detection	
69	CD MUTE R	I	CD mute (Rch) request	L : Rch mute request
70	CD MUTE L	I	CD mute (Lch) request	L : Lch mute request
71	$\overline{\text{CD MRST}}$	O	CD mechanism microcomputer reset	L : Reset, H : Normal
72	$\overline{\text{CD MSTOP}}$	O	CD mechanism microcomputer stop	L : Mechanism microcomputer stop, H : Mechanism microcomputer in operation
73	NC	-	Not used	
74	CD LOE LIM SW	I	CD detection (Chucking SW)	H : Loading complete, L : No disc
75	CD LOEJ	I/O	CD motor control	Refer to Truth Value Table (CD MOTOR / CD LOEJ)
76	CD MOTOR	O	CD motor control	Refer to Truth Value Table (CD MOTOR / CD LOEJ)
77	PON ILLUMI	I/O	Key illumination power supply control	ON : H, OFF : Hi-Z
78	PON CD	I/O	CD/WMA power supply control	At time of CD source: H, Other than CD : Hi-Z
79	PON	O	Power supply control	POWER ON : H, POWER OFF : L
80	PON FL+B	O	Fruorescent indicator tube bias power supply control	POWER ON : H, POWER OFF or display black out : L
81	PON FDC	I/O	Fruorescent indicator tube filament power supply control	POWER ON : L, POWER OFF or display black out : Hi-Z
82	F SEL1	O	SW-Reg frequency switching	
83	F SEL2	O	SW-Reg frequency switching	
84	DIAG	I/O	P-CON excess current surveillance	
85	VCC2	-		
86	EXT AMP CON	I/O	External amplifier control	
87	VSS	-		
88~91	TYPE 1~TYPE4	I	Destination switching	
92	NC	-	Not used	

MICROCOMPUTER'S TERMINAL DESCRIPTION

Pin No.	Pin Name	I/O	Function	Processing Operation
93	OEM DISP DATA	I/O	External display DATA	External display
94	OEM DISP CLK	I/O	External display CLK	External display
95	OEM DISP CE	I/O	External display control request	External display
96	NC	-	Not used.	
97	P CON	O	External amplifier control	POWER ON : H, POWER OFF or STANDBY : L
98	NC	-	Not used.	
99	ANT CONT	O	Power antenna control	TUNER ON : H
100	ILLUMI DET	I	Dimmer illumination detection	L : ON, H : OFF
101	BU DET	I	Momentary power down detection	BU : L, No BU or momentary power down : H
102	ACC DET	I	ACC power supply detection	ACC ON : L, ACC OFF : H
103	(PWIC SVR)	O	SVR discharge circuit	H : 5 seconds after POWER OFF and momentary power down, Then : L
104	PWIC MUTE	O	Power IC mute	L : When STANDBY source or momentary power down, L : When TEL MUTE
105	PWIC STBY	O	Power IC standby control	POWER ON : H, POWER OFF : L
106	LX CON	O	Start up request to slave unit	H : SLAVE UNIT ON, L : SLAVE UNIT OFF
107	MUTE PRE R	O	Rch pre-out mute	L : When "MUTE PRE R" is "L" or at momentary power down, H : Only when 2-zone
108	CD MUTE PRE L	O	Lch pre-out mute	L : When "MUTE PRE L" is "L" or at momentary power down, H : Only when 2-zone
109	MUTE 0	O	E-VOL front mute	ON : L, OFF : H
110	MUTE 1	O	E-VOL rear mute	ON : L, OFF : H
111	MUTE 2	O	E-VOL sub mute	ON : L, OFF : H
112	MUTE A	O	E-VOL spctrum analyzer mute	ON : L, OFF : H
113	DSP MUTE	I/O	DSP mute	ON : L, OFF : Hi-Z
114	MUTE C	O	E-VOL AFS mute	ON : L, OFF : H
115	DSP INIT RST	O	DSP initial reset	L : Reset, H : Reset release
116	DSP S RST	O	DSP system reset	L : Reset, H : Reset release
117	DSP RQ	O	Request to DSP	L : Request
118	DSP CS	O	DSP chip select	L : Select
119	NC (GTEST)	O	Not used	
120	LINE MUTE	I	Line mute detect	TEL MUTE : 1V or less, NAVI MUTE : 1V or less, 2.5V or more
121	MD DET	I	For a terminal of MD receiver	
122	PWIC DC DET	I	DC offset error detect	
123	LX RST	O	Hard reset to slave unit	H : Reset, L : Normal
124	G Y OUT	I	Analog Y gravity detect	
125	G X OUT	I	Analog X gravity detect	
126	RDS NOISE	I	FM noise detection	
127	AVSS	-		
128	TUN SMETER	I	S-meter input	

MICROCOMPUTER'S TERMINAL DESCRIPTION

Truth Value Table

CD MOTOR / CD LOEJ

	CD MOTOR	CD LOEJ
Standby	L	Hi-Z
Eject	H	H
Load	H	L
Brake	H	Hi-Z
Use prohibited	L	L

PANEL MECHA

	FULL OPEN	FULL CLOSE	OTHER
PM OPEN	H	L	L
PM CLOSE	H	L	H

PANEL MOTOR

	OPEN	CLOSE	STOP	WAIT
PM MOT1	L	H	H	L
PM MOT2	H	L	H	L

RDS AFS

	RDS AFS M	RDS AFS L	Condition
AFS LOW	L	L	No sound output with AF search
AFS MID	L	Hi-Z	Sound output with AF search
AFS HIGH	Hi-Z	Hi-Z	Normal reception

● PANEL MICROCOMPUTER : IC4 (X16- : SWITCH UNIT)

Pin No.	Pin Name	I/O	Function	Processing Operation
1~7	D14~D8	I/O	Data input/output	
8	3.3VDD	-		3.3V
9	VSS	-		Connect to GND
10~17	D7~D0	I/O	Data input/output	
18	FLGCP1	O	FL harmony control	Lighting timing (brightness harmony) is controlled with pulse interval. GCP=FLGCP1+FLGCP2
19	NC	-	Not used	
20	SYS REQ	I	System μ -com communication request	H : Data communication
21	SC CON	I	System μ -com communication/Panel operation control	H : Panel operation
22	FL BK	O	Fruorescent indicator blackout control	H : Fruorescent indicator turned on, L : turned off
23	2.5VDD	-		2.5V
24	VSS	-		Connect to GND
25	NC	-	Not used	
26,27	$\overline{KS1}$, $\overline{KS2}$	I/O	Key scan	L : Output, Hi-Z : Switching
28,29	TD0, TD1	-	Not used	
30,31	$\overline{KS3}$, $\overline{KS4}$	I/O	Key scan	L : Output, Hi-Z : Switching
32	TRST	-		Pull down
33	$\overline{ROTARY CCW}$	I	Rotary A	1-pulse/2-click, 15-pulse/360°
34	$\overline{ROTARY CW}$	I	Rotary B	1-pulse/2-click, 15-pulse/360°
35,36	TMS, TCM	-	Not used	
37	3.3VDD	-		3.3V
38	EVSS	-		Connect to GND
39	$\overline{KS5}$	I/O	Key scan	L : Output, Hi-Z : Switching
40~42	$\overline{KR1}$, $\overline{KR2}$, $\overline{KR3}$	I	Key return	
43	FLGCP2	O	Fruorescent indicator harmony control	Lighting timing (brightness harmony) is controlled with pulse interval. GCP=FLGCP1+FLGCP2
44	PAN REQ	O	Panel communication request	H : Data communication in progress

MICROCOMPUTER'S TERMINAL DESCRIPTION

Pin No.	Pin Name	I/O	Function	Processing Operation
45	$\overline{\text{SYS DATA}}$	I	Data reception from system μ -com	UART communication 500kbps
46	$\overline{\text{PAN DATA}}$	O	Data transmission from panel	UART communication 500kbps
47	$\overline{\text{FL CLK}}$	O	Fruorescent indicator serial communication reference clock	Reference clock 4.125MHz
48	$\overline{\text{KR4 INT}}$	I	Key return	Interruption possible
49	$\overline{\text{FL DATA1}}$	O	Fruorescent indicator serial control data	
50	$\overline{\text{CLK IN3}}$	I	Serial synchronization clock	Synchronized to Fruorescent indicator CLK
51	$\overline{\text{FL EL}}$	O	Fruorescent indicator skip shift control	H or Hi-Z : Odd number skip, L : Even number skip
52	$\overline{\text{FL DATA2}}$	O	Fruorescent indicator serial control data	
53	$\overline{\text{CLK IN2}}$	I	Serial synchronization clock	Synchronized to Fruorescent indicator CLK
54	$\overline{\text{FL LAT}}$	O	Fruorescent indicator latch control	
55	$\overline{\text{FL DATA3}}$	O	Fruorescent indicator serial control data	
56	3.3VDD	-		3.3V
57,58	X2,X1	I	Clock	6.6MHz
59	CVSS	-		Connect to GND
60	CKSEL	-		Connect to GND
61	PSEL	-		Connect to VDD
62	2.5VDD	-		2.5V
63	VSS	-		Connect to GND
64	MODE0	-		Connect to GND
65	MODE1	-		Pull down
66	$\overline{\text{PAN RST}}$	I	Input from reset IC	
67	AVDD1	I	D/A conversion reference voltage	Connect to D3.3V
68,69	NC	-		Pull down
70,71	AVSS1,AVSS0	-	D/A conversion reference GND	
72	AVDD0	-	A/D conversion reference voltage	Connect to D3.3V
73	WAVE IN	I	Voice input	AD read
74	F01	I	BPF (63Hz)	AD read
75	F02	I	BPF (150Hz)	AD read
76	F03	I	BPF (330Hz)	AD read
77	F04	I	BPF (1kHz)	AD read
78	F05	I	BPF (3.3kHz)	AD read
79	F06	I	BPF (10kHz)	AD read
80	NC	-		Pull down
81	2.5VDD	-		2.5V
82	VSS	-		Connect to GND
83	NC	-	Not used	
84	TYPE	I	Whether there is customizing or not designation setting	H : Flash ROM (This model), L : Mask ROM (Other model)
85	NC (VREFCON)	O	Not used	
86	REMO	I	Remote controller signal	Detection with pulse width
87	PON FL+B	O	Fruorescent indicator bias power supply switch	H : ON, L : OFF
88	PON FLVDD	I/O	Fruorescent indicator logic section power supply switch	H : ON, Hi-Z : OFF
89	PON 5V	I/O	5V power supply switch	Remote controller IC / Space analyzer IC power supply H : ON, Hi-Z : OFF

MICROCOMPUTER'S TERMINAL DESCRIPTION

Pin No.	Pin Name	I/O	Function	Processing Operation
90~93	NC	-	Not used	
94	\overline{WE}	I/O	Memory data write permission	L : Write, H : Wait SW3.3V start up : Hi-Z
95	\overline{OE}	I/O	Memory data transmission permission	L : Data transmission, H : Wait SW3.3V start up : Hi-Z
96,97	NC	-	Not used	
98	3.3VDD	-		3.3V
99	VSS	-		Connect to GND
100	FROMCHK	-	Not used	
101	\overline{CE}	I/O	Memory operation permission	L : Operation, H : Wait SW3.3V start up : Hi-Z
102~104	NC	-	Not used	
105	$\overline{ROMCOR SCL}$	-	Not used	
106	$\overline{ROMCOR SDA}$	-	Not used	
107	NC (SEL E2P)	-	Not used	
108	PON TRI GREEN	I/O	Triangle green light ON switch	H : Light ON, Hi-Z : Light OFF, When blackout : Light ON
109	PON TRI RED	I/O	Triangle red light ON switch	H : Light ON, Hi-Z : Light OFF
110	PON BLUE	I/O	Blue sub-illumination light ON switch	H : Light ON, Hi-Z : Light OFF
111	SA RST	O	Spectrum analyzer IC reset	H : Reset (1.8V or higher), L : Normal
112	3.3VDD	-		3.3V
113	EVSS	-		Connect to GND
114	PON GREEN	I/O	Green key illumination light ON switch	H : Light ON, Hi-Z : Light OFF
115	PON RED	I/O	Red illumination light ON switch	H : Light ON, Hi-Z : Light OFF
116	PON SW3V	I/O	Rotary encoder power supply	L : ON, Hi-Z : OFF
117	NC	O	Not used	
118~123	A21~A16	O	Address output	
124	2.5VDD	-		2.5V
125	VSS	-		Connect to GND
126~133	A15~A8	O	Address output	
134	3.3VDD	-		3.3V
135	EVSS	-		Connect to GND
136~142	A7~A1	O	Address output	
143	NC	-	Not used	
144	D15	I/O	Data input/output	

● MECHANISM MICROCOMPUTER : IC1 (X32- : CD PLAYER UNIT)

Pin No.	Pin Name	I/O	Function	Processing Operation
1	VREFL	I	ADC reference power supply input terminal (L)	GND
2	DMUTE	O	Driver MUTE	L : STOP, H : MUTE OFF
3	CSRST	O	(Decoder) Resetting control	L : RESET, H : NORMAL
4	NC	O	Not used.	Open output L-fixed
5	LZM	I	0bit MUTE detection (Lch)	L : MUTE OFF, H : MUTE ON
6	RZM	I	0bit MUTE detection (Rch)	L : MUTE OFF, H : MUTE ON
7	BREQ	I	(Decoder) BREQ signal input	
8	DSPINT	I	(DSP) interruption signal input	H : Interruption

MICROCOMPUTER'S TERMINAL DESCRIPTION

Pin No.	Pin Name	I/O	Function	Processing Operation
9	SREQ	O	(Decoder) SREQ signal output	
10	NC	O	Not used.	Open output L-fixed
11	S_DATA	O	(Decoder) Data output for serial data	
12	B_DATA	I	(Decoder) Data input for serial data	
13	CLK	O	(Decoder) Clock output for serial data	
14	DSPTXD1	O	(DSP) Data output for serial data	
15	DSPRXD1	I	(DSP) Data input for serial data	
16	DSPSCLK1	O	(DSP) Clock output for serial data	
17	AM0	-	ROM mode selection terminal	H : NORMAL, L : External ROM mode
18	DVCC	-	BU3.3V	
19	X2	O	Oscillator connection 26.88MHz	
20	DVSS	-	GND	
21	X1	I	Oscillator connection 26.88MHz	
22	AM1	-	H-fixed	
23	RESET	I	Reset detection	L : RESET H : NORMAL
24,25	NC	O	Not used.	Open output L-fixed
26	NMI	I	Non-maskable interruption Not used.	
27	ALE	O	Not used.	Open output prohibited (Hi-Z)
28	DSPSTB	O	(DSP) Data strobe signal output	
29	DSPA0	O	(DSP) Command parameter identification signal output	H : Transmitting parameter, L : Transmitting command
30	DSPRST	O	(DSP) Reset control	
31	NC	O	Not used.	Open output L-fixed
32	NC	O	Not used.	Open output L-fixed
33	SEARCH	O	Search condition output	H : In search, L : Normal (x2 : L-fixed)
34	LOE/LIM_SW	I	PU LIM detection SW	H : LIM
35~39	NC	O	Not used.	Open output L-fixed
40	POND3.3	O	D3.3V POWER ON control terminal	H : POWER ON
41	NC	O	Not used.	Open output L-fixed
42	PONCS	O	CS7410-series power supply control terminal	H:POWER ON
43~47	NC	O	Not used.	Open output L-fixed
48	DATA_MUTE	O	Data output status	L : DATA output MUTE
49	NC	O	Not used.	Open output L-fixed
50	NC (BOOT)	O	Mask : Not used. (output H) / Flash (write terminal)	(Flash) L : WRITE, H : NORMAL
51~53	NC	O	Not used.	Open output L-fixed
54	MUTE L	O	Lch audio MUTE control	L : MUTE ON
55	MUTE R	O	Rch audio MUTE control	L : MUTE ON
56	NC	O	Not used.	Open output L-fixed
57	SDA	I/O	(System μ -com) I2C data	
58	SCL	I/O	(System μ -com) I2C clock	
59	MSTOP	I	Standby restart interruption	L:STOP H:STOP release
60~62	AN0~AN2	I	TEST0~TEST2	PULL DOWN
63	UNQID	I	Unique ID write permission	L : Normal, H : During service write
64	AVCC	-	ADC power supply terminal	BU3.3V

TEST MODE

● How to enter the test mode

In order to enter the test mode, reset the unit while simultaneously pressing down [1] and [3] keys.

● How to clear the test mode

The test mode is cleared in case of any of the following events: resetting, momentary power down, Acc OFF, Power OFF and removal of the panel.

● Initial conditions of the test mode

- Source is STANDBY.
- Displays lights are all turned on.
- The volume is at -10dB (The display is 30).
- Loudness (LOUD) is OFF.
- CRSC is OFF, regardless of whether there are switching functions or not.
- SYSTEM Q is NATURAL (=FLAT).
- BEEP will sound anytime with a less than 1 second push.
- Auxiliary (AUX) is ON.
- DISPLAY TYPE is TYPE D.
- The Multi-function Key System are source dependent systems. (TUNER → Preset, CD / CD-CH → Scan, etc.)
- Display of TUNER sources will be as follows :
European Models : Upper Display=PS/frequency, Middle Display=spectrum analyzer, Lower Display=multi-function
Other Models : Upper Display=SNPS, Middle Display =spectrum analyzer, Lower Display=multi-function
- CD source display will be as follows :
All Models : Upper Display=P-TIME, Middle Display= spectrum analyzer, Lower Display=multi-function
- SWPRE is SUB WOOFER.

● RDS automatic measurement

Conventionally, the PS display has been visually checked on the production line. This will be replaced by a new processing. The PS data will be received and the PS contents is to be verified as "RDS_TEST". When this is verified, the P-CON terminal is forced to go OFF. (In this case, "_" means blank.)

→ This will be a dedicated test mode processing.

On the P-CON, when power is turned off once and, then, turned on again, (Power OFF → ON) the unit will be restarted.

● Special display when set to TUNER

When in TUNER mode, if any of the following displays appear, there is an abnormality with the front end.

- "TNE2P_NG" : At production site, the E2PROM is still with the default (unspecified) value, due to the fact that the front-end being shipped without going through the adjustment process.
- "TNCON_NG" : In this condition, the communication with the front-end is not possible.

● Forced switching of K3I

In TUNER FM mode, each time [6] key is pressed, the functions move in the following cycle :

AUTO → forced WIDE → forced MIDDLE → force NARROW → AUTO

The initial condition is AUTO and the displays below will appear.

- AUTO : FMA
- Forced MIDDLE : FMM
- Forced WIDE : FMW
- Forced NARROW : FMN

● CD receiver test mode specifications

- Jumps are made to the following tracks by pressing the [▶▶1] key.
No. 9 → No. 15 → No. 10 → No. 11 → No. 12 → No. 13 → No. 22 → No. 14 → No. 9 (Returns to the beginning)
It must be noted, however, that when paying MP3 / WMA / AAC disk, which contain 8 files or less, the first track and the following tracks are played in order.
- When [◀◀1] key is pressed, it goes down by 1 track.
- When a CD is used as a source, by pressing [1] key for less than 1 second, a jump to the Track No. 28 is made.
- When a CD is used as a source, by pressing [2] key for less than 1 second, a jump to the Track No. 14 is made.
- When a CD is used as a source, by pressing [3] key for less than 1 second, a display of CD mechanism model name and its version is made. When the pressing of [3] key for less than 1 second is made for the second time, the normal display is resumed. (Time code display)
- When a CD is used as a source, by pressing [6] key for less than 1 second, a jump to the Track No. 15 is made. At the same time, the volume value is set to 25 (2V PRE) and 27 (5V PRE).

TEST MODE

● Audio adjust mode

Model with DSP (KDC-MP828/X889)

- By pressing [AUD] key for less than 1 second, the Audio Adjust mode is entered.
- As with the [AUD] key, [*] key on the remote controller can be used to enter the Audio Adjust mode.
- As for the adjustment items, items for both the AUDIO FUNCTION MODE and SETUP MODE are included.
- The initial item will be Fader and the next is Balance. (After Balance, it will be arbitrary.)
- With the remote controller, continuous forwarding is prohibited.
- Using the VOL knob, the Fader is to be adjusted to the following 3 levels : R15 ↔ 0 ↔ F15 (The default value : 0)
- Using the VOL knob, the Balance is to be adjusted to the following 3 levels : L15 ↔ 0 ↔ R15 (The default value : 0)
- Using the VOL knob, the Sub Woofer Level is to be adjusted to the following 3 levels : -15 ↔ 0 ↔ +15 (The default value : 0)
- Using the VOL knob, the Volume Offset is to be adjusted to the following 2 levels : -8 ↔ 0 (The default value : 0)

Model with no DSP (KDC-W7531/W7531Y/W8531/ W8531Y/X789/X8529)

- By pressing [AUD] key for less than 1 second, the audio adjustment mode can be entered.
- Using the remote controller [*] key and [AUD] key, the audio adjustment mode can be entered.
- Adjustment items of both the AUDIO FUNCTION MODE and SETUP MODE are included.
- The initial item will be Fader, which is followed by : Balance → Bass Level → Middle Level → Treble Level → (Sub Woofer Level) → HPF Front → HPF Rear → LPF Sub Woofer (After this, it will be arbitrary)
- With the remote controller, continuous forwarding is prohibited.
- Using the VOL knob, the Fader can be adjusted in 3 steps : R15 ↔ 0 ↔ F15 (The initial value is 0)
- Using the VOL knob, the Balance can be adjusted in 3 steps : L15 ↔ 0 ↔ R15 (The initial value is 0)
- Using the VOL knob, the Bass / Middle / Treble Level can be adjusted in 3 steps : -8 ↔ 0 ↔ +8 (The initial value is 0)

- Using the VOL knob, the Sub Woofer Level can be adjusted in 3 steps : -15 ↔ 0 ↔ +15 (The initial value is 0)
- Using the VOL knob, the Volume Offset can be adjusted in 2 steps : -8 ↔ 0 (The initial value is 0)
- Using the VOL knob, the HPF Front / Rear can be adjusted in 2 steps : Through ↔ 180Hz (or 220Hz) (The initial value is Through)
- Using the VOL knob, the LPF Sub Woofer can be adjusted in 2 steps : 60Hz (or 50Hz) ↔ Through (The initial value is Through)
- Using the VOL knob, the Sub Woofer Phase can be adjusted in 2 steps : Reverse ↔ Normal (The initial value is Normal)
- Using the VOL knob, the Volume Offset can be adjusted in 2 steps : -8 ↔ 0 (The initial value is 0)
- Using the VOL knob, the Loudness ON/OFF can be adjusted in 2 steps : OFF ↔ ON (The initial value is OFF)
- 2-Zone ON/OFF can be adjusted in 2 steps : OFF ↔ ON (The initial value is OFF)
- Bass f / Bass Q / Bass EXT / Middle f / Middle Q / Treble f do not appear in audio adjustments.

● MENU items

- Push the [NEXT] (NEXT) key for at least 1 second to enter the MENU.
- The [DNPP/SBF] and [DIRECT] keys on the remote controller can also be used to enter the MENU.
- With the remote controller, continuous forwarding is prohibited.
- When a CD is used as a source, the default item will be the ACD F/W Version.

● 2-ZONE (Dual Zone) items

- When using sources other than the STANDBY source, using a short-press on [AUTO] or [TI] key, 2-ZONE ON/OFF is achieved.

● Backup current measurement

When reset in Acc OFF (Back Up ON) condition, MUTE terminal goes off after 2 seconds, instead of 15 seconds. (During this time, the CD mechanism does not function.)

TEST MODE

● OPEL communication items

During the test mode, OPEL communication line outputs the following (At every 500msec, the output condition of the communication line will be switched.)

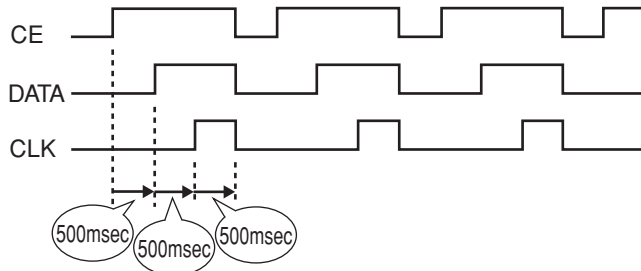

● G sensor display items

When source is STANDBY, by short-pressing [ATT] key, the display is switched to analogy meter display, in which vertical G and horizontal G are displayed.

● Special display when all lights are on

When all lights are on with the STANDBY source, the following displays are made when the keys shown below are pressed.

[1] key	Version display (Display) C-408WK_SYS_1. 23 (Display) _____PAN_1. 11 (Display) _____MEM_3. 21
[2] key	Serial number display (8 digits) (Display) SNo_XXXXXXXX
[3] key	Press for less than 1 second : Power ON time is displayed. During Power On time display, by pressing for at least 2 seconds, the Power ON time is cleared. (Display) PonTim_XXXXX MAX 65535 (hours)
[4] key	Press for less than 1 second : CD operation time is displayed. During CD operation time display, by pressing for at least 2 seconds, CD operation time is cleared. (Display) CDTim_0XXXXX MAX 65535 (hours)
[5] key	Press for less than 1 second : CD EJECT number is displayed. During CD EJECT number display, by pressing for at least 2 seconds, CD EJECT number display is cleared. (Display) EjeCnt_XXXXX MAX 65535 (times)

[6] key	Press for less than 1 second : PANEL Open/close number is displayed. (*1) During PANEL Open/close number display, by pressing for at least 2 seconds, PANEL Open/close numbers is cleared. (Display) PnCnT_XXXXXX MAX 65535(times)
[FM] key	ROM correction version display (Display) SYS_ROM_R123 (Display) PAN_ROM_R123 When E2PROM is not installed : ROM_ERR_ When un-written : ROM_R --- When data is incompatible : ROM_R * * *
▶▶▶ key	AUDIO data default value setting (Display) AUDIO_INIT
◀◀◀ key	Press for less than 1 second : CD mechanism error log display During CD mechanism error log display; by pressing for at least 2 seconds, all error log information is cleared. (Display) l2C_●● (Display) ERR_1-▲▲, 2-▲▲, 3-▲▲ * In "●●", "OK" or "NG" is displayed. In "▲▲", "--" or an error code is displayed.

(*1) : 1 count is made when the panel opens to full or when a disc is loaded.

● Initializing AUDIO-related value setting

During STANDBY sourcing, by pressing [▶▶▶] key for less than 1 second, AUDIO setting values are returned to the default values.

● Flash ROM check

1. In order to prevent the Flash ROM (4M) equipped models to be installed with the Mask ROM (2M) panel, and to prevent the Mask ROM (2M) equipped models to be installed with the Flash ROM (4M) panels, with the STANDBY sources during the test mode, the following display will be made according to the system μ -com and panel combination.

- Flash ROM (4M) equipped model and Flash ROM (4M) panel
All lights turned on --- OK!
- Mask ROM (2M) equipped model and Mask ROM (2M) panel
All lights turned on --- OK!
- Flash ROM (4M) equipped model and Mask ROM (2M) panel
"M4P2" --- NG!
- Mask ROM (2M) equipped model and Flash ROM (4M) panel
"M2P4" --- NG!

TEST MODE

- When entering the test mode, the manufacture code of the Flash ROM (4M) is read and when it is normal, FROMCHK of the 100th terminal (Panel μ -com) repeats Hi \rightarrow Low \rightarrow Hi $\cdot\cdot\cdot$. If the reading is abnormal, "Low" is output.
If the manufacture code is normal, by pressing [▶▶I] key for less than 1 second, the connection checks on all terminal is started. If the connections are normal, the FROMCHK terminal stops the Hi \rightarrow Low \rightarrow Hi $\cdot\cdot\cdot$ repeating and outputs "Hi". If the reading is abnormal, "Low" is output.
- With all lights turned on and by pressing [AM] key for at least 1 second, the data on the Flash ROM (4M) is initialized. While erasing the data, "Data_Erase..." is displayed.
Note : Do not touch any key while this is in progress.
When erasing is complete, "Erase_OK!!" is displayed.
If "Erase_NG!!!!!" is displayed, it was not possible to erase the data on the Flash ROM (4M).
In this case, pressing [AM] key for at least 1 second again.
If it is the same, then there is an abnormality with the Flash ROM.

● Other

- At Power ON, "CODE_OFF", "CODE_ON" displays will not be made.
- When sourcing STANDBY, by pressing [AUTO] or [TI] key for less than 1 second, GREEN/RED of the key illumination is switched.
When doing this, the triangle illumination GREEN/RED is switched along with the key illumination.
- When starting up in the test mode, LINE MUTE prohibition time is set to 1 second instead of 10 seconds.
- While in the test mode, even when a DC offset error is detected, the detection information will not be written to the E2PROM.
- While in the test mode, even after an elapse of pre-set time, the backup memory items will not be written to the E2PROM.
- Information Clear mode for Test Mode, backup/installer memory, and CD mechanism error log.
In the DC offset error detection information clear mode, DEMO mode operation will not be conducted.
Also, in the above mode, the menu of the STANDBY source will not display DEMO ON/OFF switching items.

- While in the test mode, and at the same time, PM_DET of the 60th terminal (System μ -com) is H, the following will apply to the EJECT key, regardless of whether a disc is in the unit or not.
Panel full OPEN/CLOSE is conducted with a push for less than 1 second. (Protection time : 3 seconds)
As far as this item is concerned, eject will be achieved by for at least 1 second push on the EJECT key.

● Clearing backup memory and installer memory data (Clearing E2PROM data)

- By pressing [↵] (NEXT) key and [ATT] key simultaneously, reset and start the unit. This will start the initialization processes for backup and installer memory data and the error log information of the CD mechanism.
- When initialization is complete, the following display will be made.

Normal completion

```
CD_E2P____:○  
AUDIO_E2P:○
```

Abnormal ending 1 : backup/installer memory initialization : NG

```
CD_E2P____:○  
AUDIO_E2P:×
```

Abnormal ending 2 : CD mechanism error log initialization : NG

```
CD_E2P____:×
```

```
AUDIO_E2P:○
```

Abnormal ending 3 : All initialization : NG

```
CD_E2P____:×
```

```
AUDIO_E2P:×
```

- While in this mode, even after an elapse of a pre-set time, no backup memory items will be written to the E2PROM.
- This mode is released by resetting. (What was on the last screen will not be retained.)

TEST MODE

● Clearing DC offset error detection information (E2PROM data clear)

1. While simultaneously pressing down on [3] and [6] keys, reset the unit to enter the DC offset error display mode.
2. During STANDBY sourcing, the current DC offset error conditions will be displayed.
When error detected : "DC_ERR"
When error not detected : "DC_OK"
3. While the error conditions are being displayed, press [AUTO] or [TI] key for less than 1 second to clear the detection information. (E2PROM clear)
4. DC offset error display mode is released by resetting. (What was on the last screen will not be retained.)

● FM/AM channel space switching (KDC-MP828/X789/X8529/X889)

From the Power OFF condition, while pressing [1] and [5] keys down simultaneously, press the [SRC] key and turn power ON.

● Security

• Forced Power ON mode

While "----" is being displayed, by resetting while pressing [NEXT] key and [4] key simultaneously, it is possible to turn the power ON for 30 minutes only.

● Method of clearing the programmable security code (KDC-MP828/X789/X889)

1. While "----" is being displayed, press [▶▶] key for at least 3 seconds while pressing [AUTO] key.
This makes "----" display disappear.
2. Using the remote controller, input "KCAR".
Press remote controller [5] key 2 times (Input for "K") and then press [▶▶] key.
Press remote controller [2] key 3 times (Input for "C") and then press [▶▶] key.
Press remote controller [2] key once (Input for "A") and then press [▶▶] key.
Press remote controller [7] key 2 times (Input for "R") and then press [▶▶] key.
3. The security is released and the unit enters the STANDBY mode.
4. If a wrong code is input, the unit goes into the Code Request mode.

• How to register the security code on the "Car Audio Passport" after replacement of the E2PROM (KDC-W7531/W7531Y/W8531/W8531Y/X8529)

1. Enter the test mode. (Refer to the section on "How to Enter the Test Mode.")
2. Enter the MENU by long pressing [NEXT] (NEXT) key for one second.
While "Security" is being displayed, press [▶▶] key for at least 1 second and enter the security registration mode.
3. Using [FM] / [AM] / [◀◀] / [▶▶] keys, enter the code.
[FM] key : Number up / [AM] key : Number down
[▶▶] key : Cursor Right / [◀◀] key : Cursor Left
4. Press [▶▶] key for at least 3 seconds to display "RE-ENTER". Then, re-enter the code using the method in above No. "3".
5. Press [▶▶] key for at least 3 seconds to display "APPROVED".
6. Release the test mode. (Refer to the section on "How to Release the Test Mode.")

Note : The security code for this model cannot be deleted by "all clear" command.

HOW TO WRITE THE UNIQUE ID

1. Introduction

The Unique ID is an identification code allocated to each DXM-6800 mechanism unit. When written to the mechanism unit, the ID is stored in the Flash memory area, managed by the DSP.

During servicing of the unit, if and when the mechanism assembly is replaced, the Unique ID of the old unit should be written to the new mechanism assembly. At the same time, after moving the Unique ID, the ID seal must also be moved. The descriptions herein concern writing Unique ID, using the functions of the DXM-6800 mechanism. It is possible to easily re-write the Unique ID of the mechanism, using this function.

* DXM-6800 : X92-5100-00

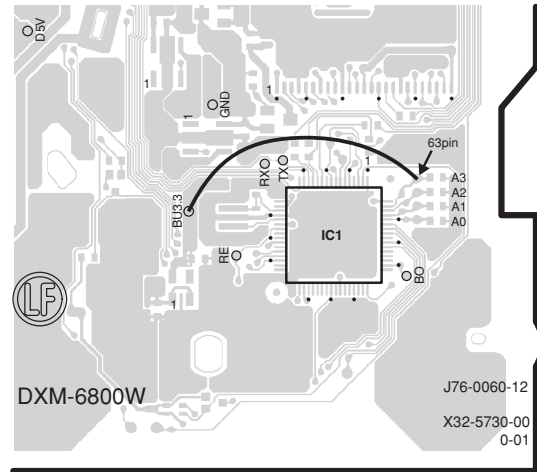

2. Unique ID

The Unique ID is an identification code allocated to each DXM-6800 mechanism unit. This ID is consisted of 8-digit hexadecimal numbers.

Example : 9F346D22, 352899AC, etc.

The ID number seal is placed on top of the mechanism cabinet. The 8-digit numbers and characters are the Unique ID assigned to the mechanism. The Unique ID can be confirmed in the MENU mode.

3. How to write the Unique ID, using the unit

In this section, the procedure for writing the Unique ID with the unit is explained. Since this procedure is realized by putting the mechanism into a special mode, the unit must first be reset, immediately before conducting the procedure. At the same time, the display mode of the unit must be set to P-Time, prior to shifting into the write mode. Unless set to P-time, 5 seconds after shifting into the write mode, ID digits and ID numbers will be stopped from displaying.

3.1. How to shift into the Unique ID writing mode using the unit

Procedure 1. Set the 63pin of the mechanism microcomputer (TMP91CU27) to High.
(Connect X32 : IC1 63pin and Back Up 3.3V with a lead.)

Procedure 2. Reset the mechanism microcomputer and boot it up again.

(Resetting the mechanism microcomputer and booting it up again can be achieved by cutting off ACC and Back Up power supply once and then re-starting the unit.)

Procedure 3. Insert a CD and use it as a source (i.e. let the unit start reading the Disc.)

Procedure 4. This completes the start up on Unique ID Write mode.

After shifting into the Unique ID Write mode, the display will be as shown in the figure below.

(In the Unique ID Write mode, actually, ② is displayed first and, after pressing FF key once in the Write mode, ① is displayed.)



Figure1. Initial display of the Unique ID Write mode

Where,

① Unique ID

The contents of what are indicated by x : xx in the time code is the actual contents of the Unique ID.

In sections of minutes : seconds, the Unique ID is indicated in decimal numbers.

HOW TO WRITE THE UNIQUE ID

The table below is the correspondence between the decimal and hexadecimal numbers.

Decimal numbers	00	01	02	03	04	05	06	07
Hexadecimal numbers	0	1	2	3	4	5	6	7
Decimal numbers	08	09	10	11	12	13	14	15
Hexadecimal numbers	8	9	A	B	C	D	E	F

The Unique ID indicated in the [minutes] section is the target Unique ID of the current procedure for writing the ID. The Unique ID in the [seconds] section indicates the next Unique ID that is to replace the current Unique ID. The digit numbers of the Unique ID will be displayed in the Track Number section of ②.

② Unique ID digit number :

The digit numbers of the Unique ID are numbered 1, 2, 3, from the left side of the Unique ID.

The contents indicated by T-xx in the track number section are the digit number of the Unique ID displayed currently in ①. The first digit is the digit number of the Unique ID, which is currently worked upon and displayed in the [minute] section of the time code. The second digit is the next digit number of the Unique ID, which is indicated in the [seconds] section of the time code. The values of the T-xx will be changed as the target of the changed Unique ID is moved in the following manner : T-12 → T-23 → T-34 → T-45 → T-78 → T-81 → ... The value in the higher digit (i.e. "1" of T-12, for example) is the current target for change in the Unique ID.

After the Unique ID has been changed in all of its digits and as the writing takes place, the progress condition of writing is indicated in the ② section.

The display contents are;

- T-99 : Unique ID writing in progress.
- T-11 : Unique ID Writing complete (success)
- T-22 : Unique ID Writing complete (failure)

Procedure 5. Changing Unique ID write contents

Using Track Up/Down Key, Unique ID contents is changed.

(In this unit, CONTROL Key is pushed to the left or right.)

Using FF/FR Key, Unique ID digit to be worked upon is changed.

(In this unit, the CONTROL Key is pushed 1 second or more to the left or right)

Procedure 6. Final write contents is determined and written to the mechanism.

Using Pause key, the ID is written. (In this unit, the center section of the CONTROL Key is to be pressed.)

Procedure 7. 63pin of the mechanism microcomputer (TMP91CU27) is set back to Low.

(Connection lead is removed.)

Procedure 8. Reset the mechanism microcomputer, and start it up.

(Resetting the mechanism microcomputer and booting it up again can be achieved by cutting off ACC and Back Up power supply once and then re-starting the unit.)

Procedure 9. Insert a Compact Disc (CD) and select CD as the source. This determines the type of media to be played. Then, select from the MENU of the unit "ACD Unique ID." This is done to confirm on the write content of the Unique ID.

When re-doing the procedure, start from Procedure 1 again.

3.2. How to change the Unique ID write content: Explanation on the Procedures 5-6.

When shifting to the Unique ID Write mode, the display will be as shown in Figure 1. This is the beginning of writing. At this point, as has been indicated above, the digit for 10's in the T-xx is the Unique ID digit which is subject for change and its contents is shown in the [minutes] section of the time code.

Then, actual change procedure is as follows :

The table below shows the keys to be used.

Track Up key	Push the CONTROL Key to left	Unique ID contents +1 of digit which is currently subject to change.
Track Down key	Push the CONTROL Key to right	Unique ID contents -1 of digit which is currently subject to change.
FF key	Push the CONTROL Key to left for more than 1 second.	Digit subject to change +1
FR key	Push the CONTROL Key to right for more than 1 second	Digit subject to change -1
Pause key	Push the CONTROL Key at center	Writing Unique ID

Table1. Key to be used in Unique ID Writing mode

HOW TO WRITE THE UNIQUE ID

3.3. Example of the case of ID to be written is “94850ED2”

(Example1). Subject digit of the Unique ID to be changed +1
The subject digit is 3, 3 digit Unique ID is 08 (hexadecimal : 8), the value +1 is 09 (hexadecimal : 9).

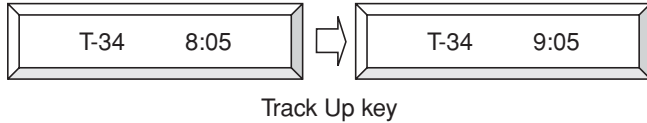

(Example2). Subject digit of the Unique ID to be changed -1
The subject digit is 7, 7 digit Unique ID is 13 (hexadecimal : D), the value -1 is 12 (hexadecimal : C).

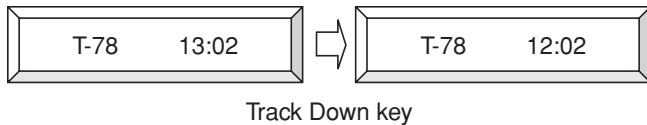

(Example3). Digit subject to change +1
The current digit subject to change is 7, digit subject to change +1 is 8.

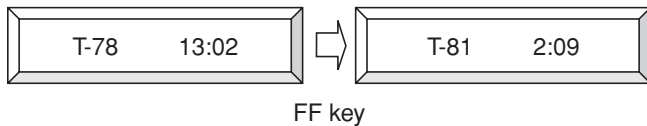

(Example4). Digit subject to change -1
The current digit subject to change is 3, digit subject to change -1 is 2.

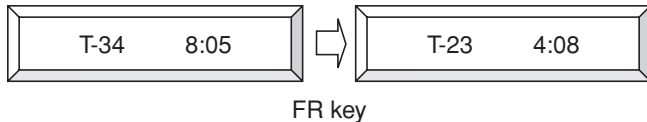

(Example5). Determination of Unique ID (Writing)

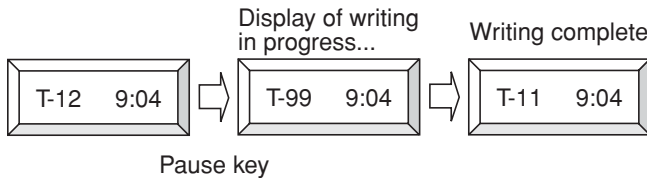

4. Note :

- When in the Unique ID Write mode, the written Unique ID is not displayed. The terminal of the mechanism microcomputer must be put back to what it was before (63pin to Low). Then, reset the microcomputer and re-boot it for confirming the newly written Unique ID is correct.
How to view the Unique ID
 - ① Boot in normal mode (Not the Write mode)
 - ② Insert a CD and set the CD as the source
 - ③ When reading CD is complete and the media is determined, select “ACD ID” from the unit MENU.
- After writing the Unique ID on the current mechanism, transfer the ID number seal from the old mechanism.
- In order to start the special mode (Unique ID Write mode), the 63pin must be changed to High for mode change. When doing this, BU3.3V should be connected as the power supply. In the special mode, when reset, the setting must be changed to High. Unless this is done, the mode does not work. Therefore, the setting must be completed as indicated.

PC BOARD (COMPONENT SIDE VIEW)

ELECTRIC UNIT
X34-3xxx-xx (J76-0053-22)

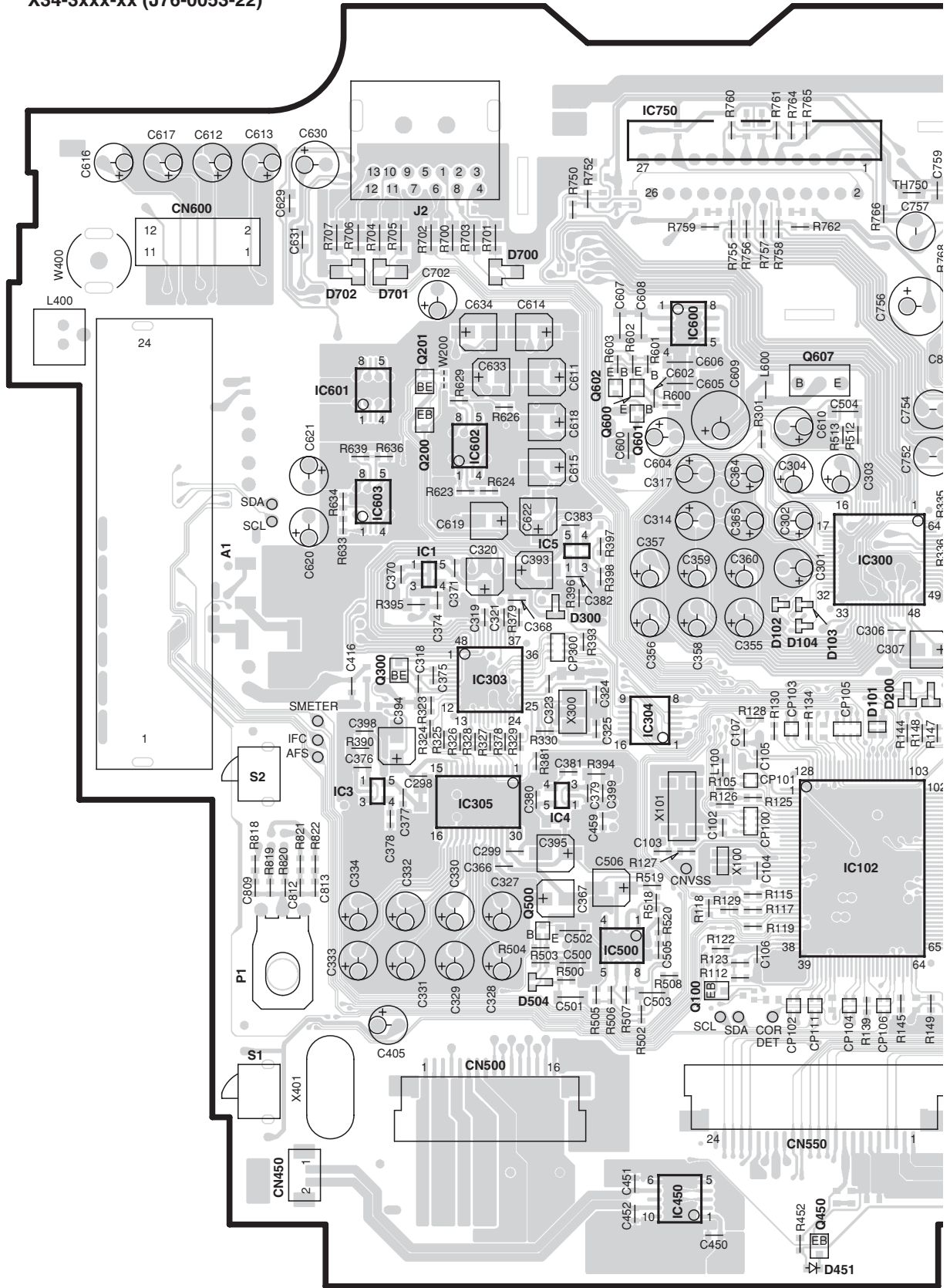

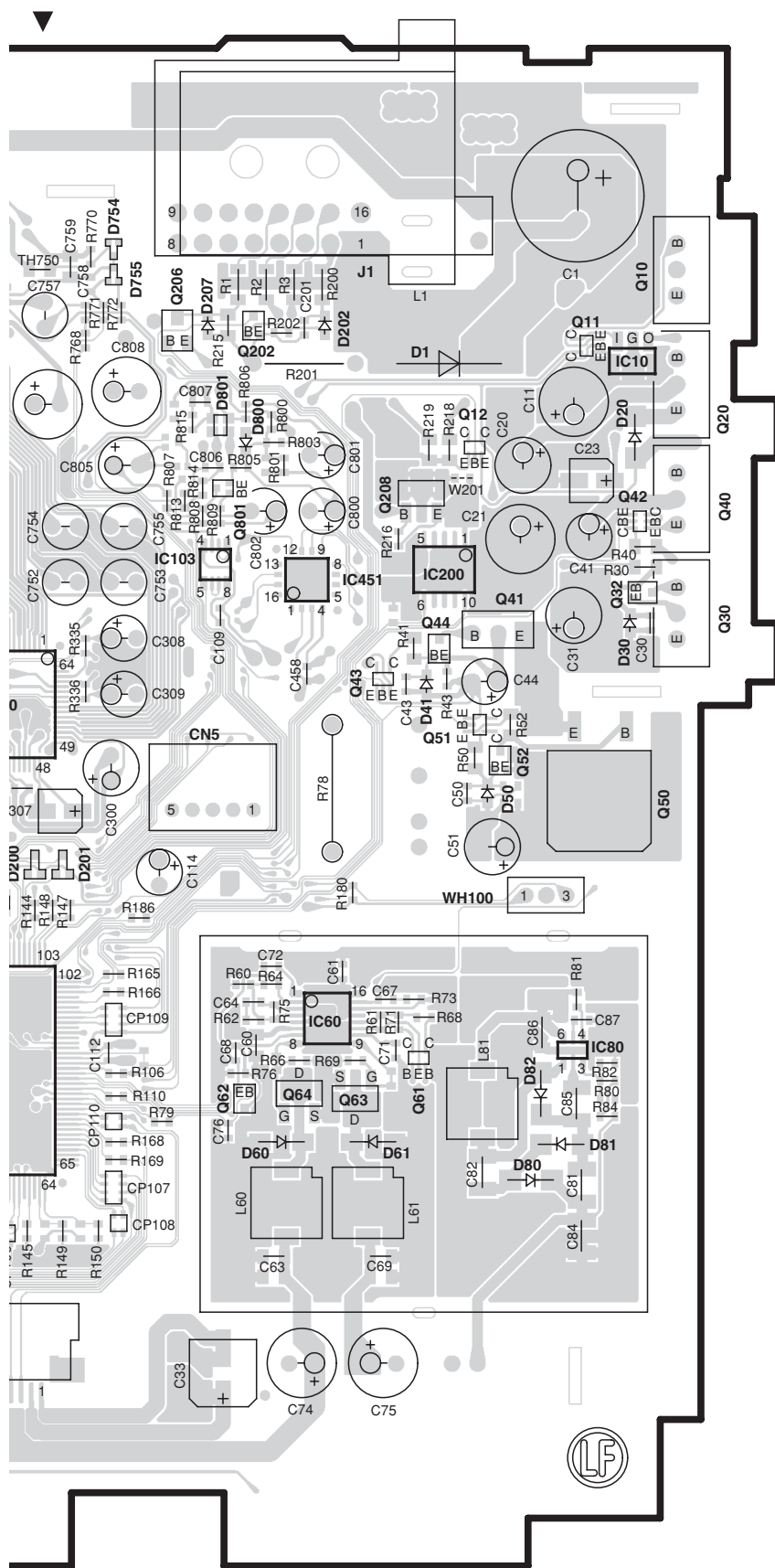

X34-3xxx-xx

Ref. No.	Address	Ref. No.	Address
IC1	4H	Q32	3M
IC3	5H	Q40	3M
IC4	5I	Q41	3L
IC5	4I	Q42	3M
IC10	3M	Q43	4L
IC60	5L	Q44	4L
IC80	5M	Q50	4M
IC102	5J	Q51	4L
IC103	3K	Q52	4L
IC200	3L	Q61	5L
IC300	4J	Q62	5K
IC303	4H	Q63	5L
IC304	4I	Q64	5L
IC305	5H	Q100	6I
IC450	7I	Q200	3H
IC451	3L	Q201	3H
IC500	5I	Q202	3K
IC600	3I	Q206	2K
IC601	3H	Q208	3L
IC602	3H	Q300	4H
IC603	4H	Q450	7J
IC750	2I	Q500	5I
Q10	2M	Q600	3I
Q11	2M	Q601	3I
Q12	3L	Q602	3I
Q20	3M	Q607	3J
Q30	3M	Q801	3K

Refer to the schematic diagram for the values of resistors and capacitors.

PC BOARD (FOIL SIDE VIEW)

ELECTRIC UNIT
X34-3xxx-xx (J76-0053-22)

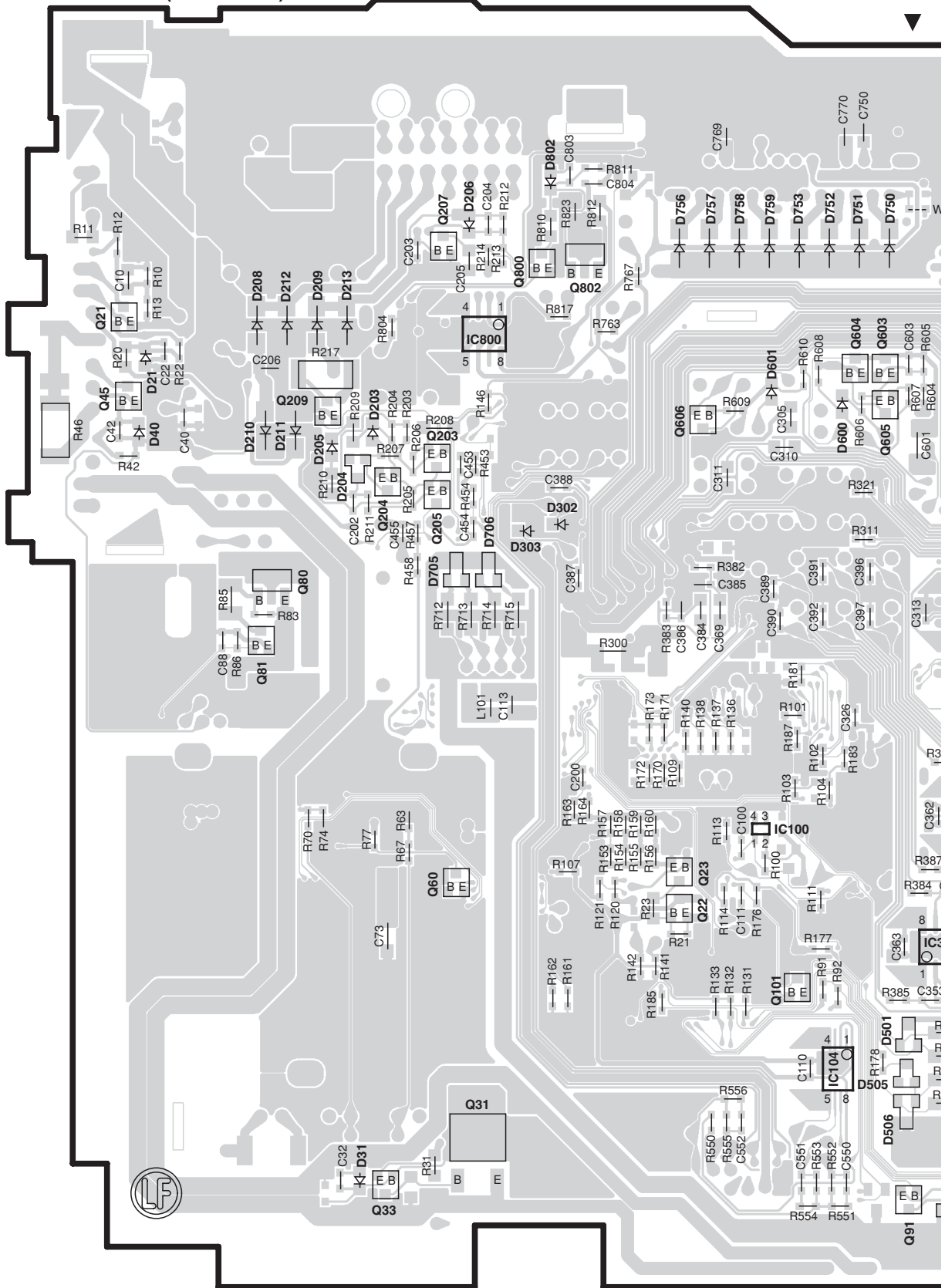

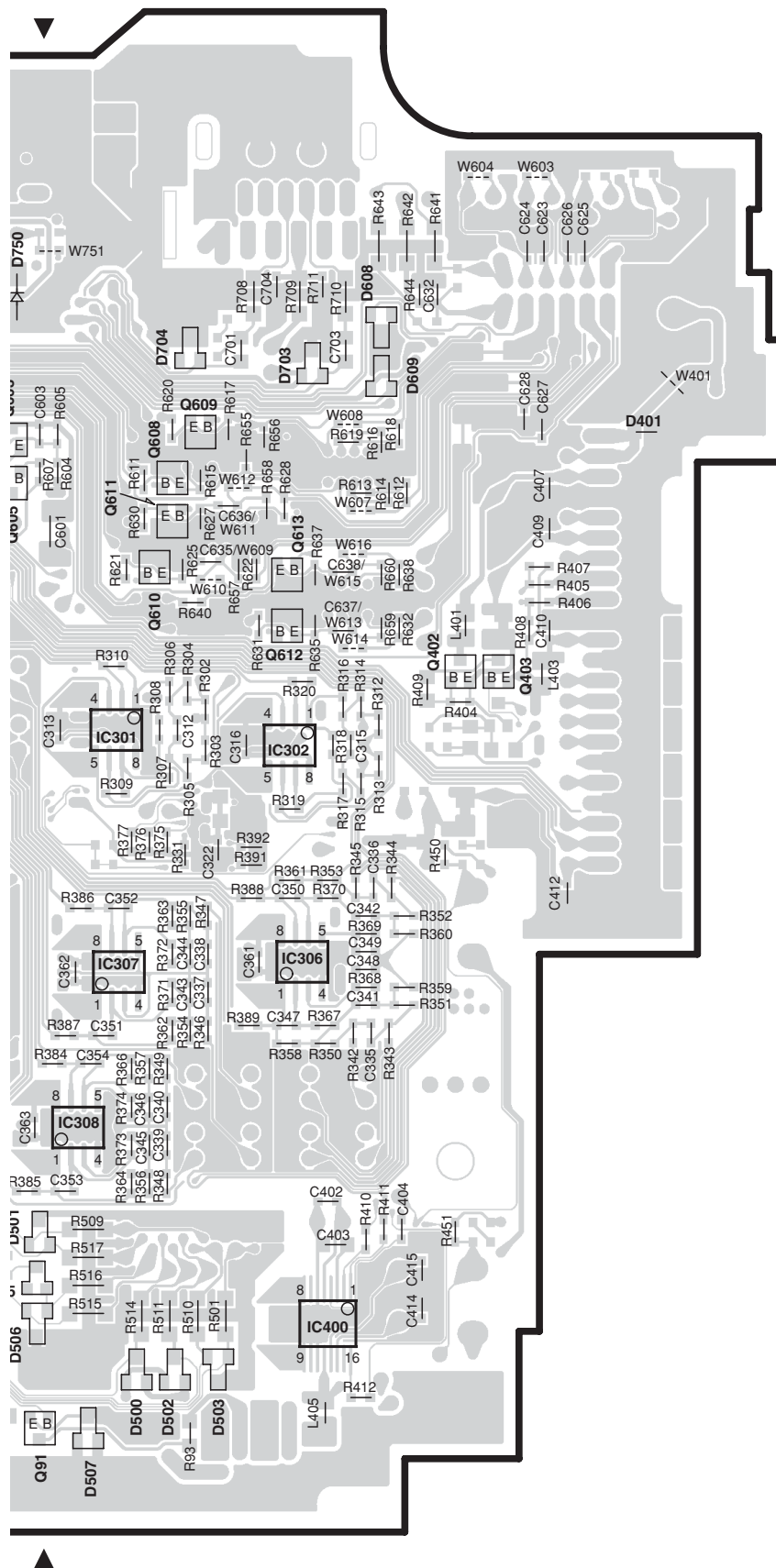

X34-3xxx-xx

Ref. No.	Address	Ref. No.	Address
IC100	5T	Q203	3R
IC104	6T	Q204	4R
IC301	4U	Q205	4R
IC302	4V	Q207	2R
IC306	5V	Q209	3R
IC307	5U	Q402	4V
IC308	5U	Q403	4V
IC400	6V	Q603	3T
IC800	3R	Q604	3T
Q21	3Q	Q605	3T
Q22	5S	Q606	3S
Q23	5S	Q608	3U
Q31	6R	Q609	3U
Q33	7R	Q610	4U
Q45	3Q	Q611	3U
Q60	5R	Q612	4V
Q80	4R	Q613	3V
Q81	4Q	Q800	3S
Q91	7T	Q802	3S
Q101	6T		

Refer to the schematic diagram for the values of resistors and capacitors.

KDC-MP828/W7531/W7531Y/W8531
/W8531Y/X789/X8529/X889

PC BOARD (COMPONENT SIDE VIEW)

CD PLAYER UNIT X32-5730-00 (J76-0060-12)

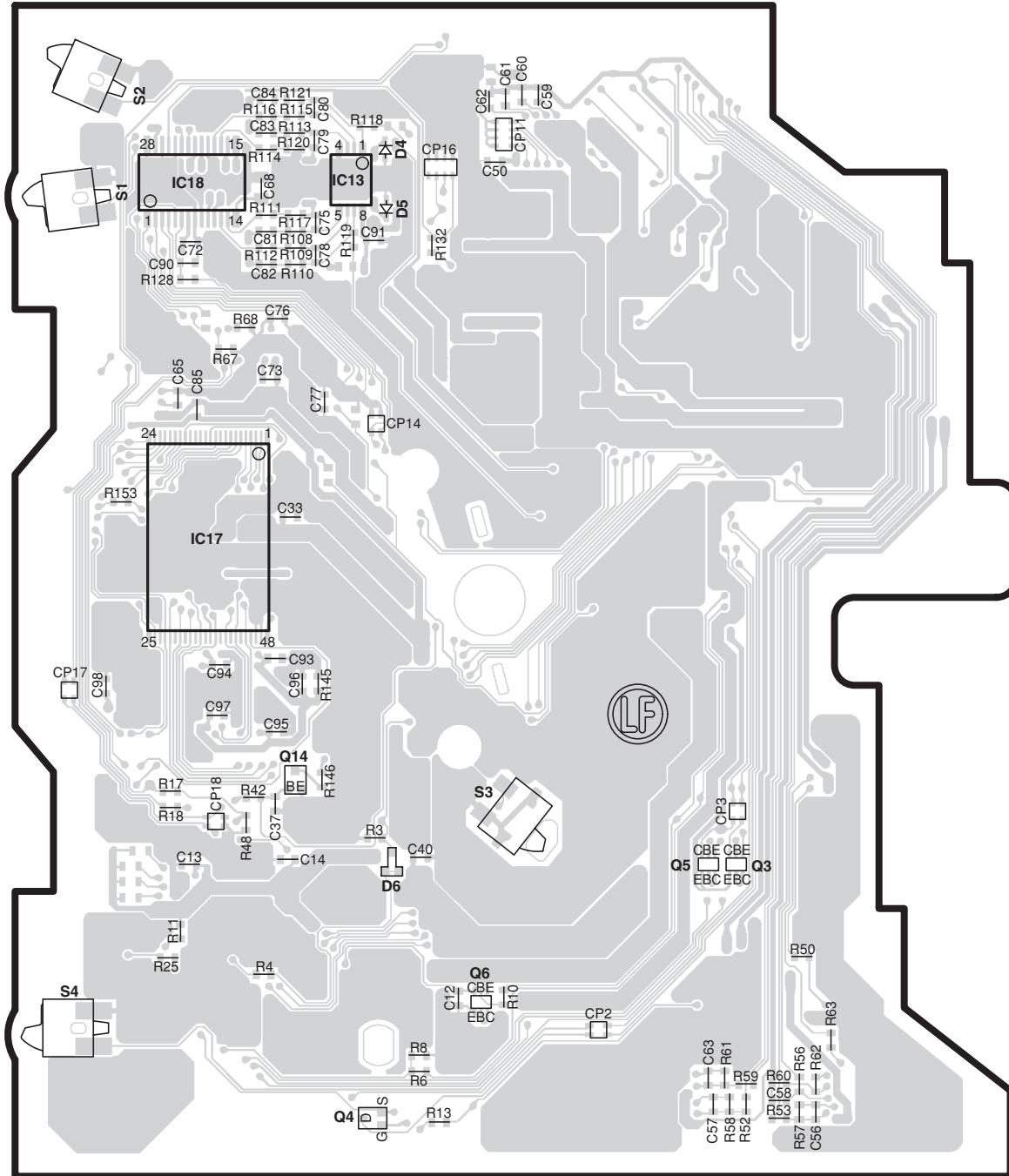

X32-5730-00

Ref. No.	Address	Ref. No.	Address
IC13	2AB	Q4	6AB
IC17	3AA	Q5	5AC
IC18	2AA	Q6	5AB
Q3	5AC	Q14	4AA

Refer to the schematic diagram for the values of resistors and capacitors.

PC BOARD (FOIL SIDE VIEW)

CD PLAYER UNIT X32-5730-00 (J76-0060-12)

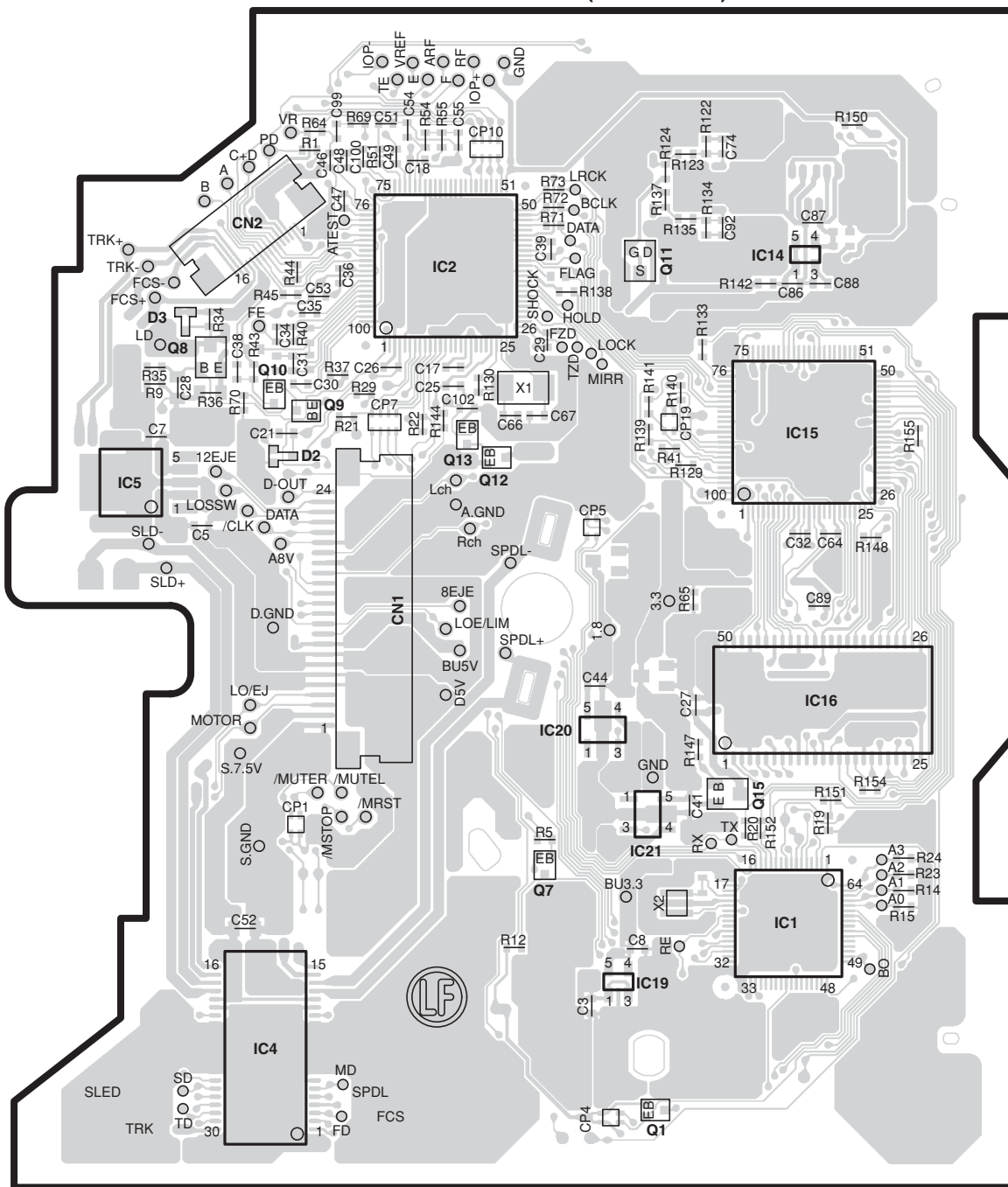

X32-5730-00

Ref. No.	Address	Ref. No.	Address	Ref. No.	Address
IC1	5AH	IC19	5AG	Q10	3AF
IC2	2AG	IC20	4AG	Q11	2AG
IC4	5AF	IC21	5AG	Q12	3AG
IC5	3AE	Q1	6AG	Q13	3AG
IC14	2AH	Q7	5AG	Q15	4AH
IC15	3AH	Q8	3AF		
IC16	4AH	Q9	3AF		

Refer to the schematic diagram for the values of resistors and capacitors.

ELECTRIC UNIT (X34-3xxx-xx)

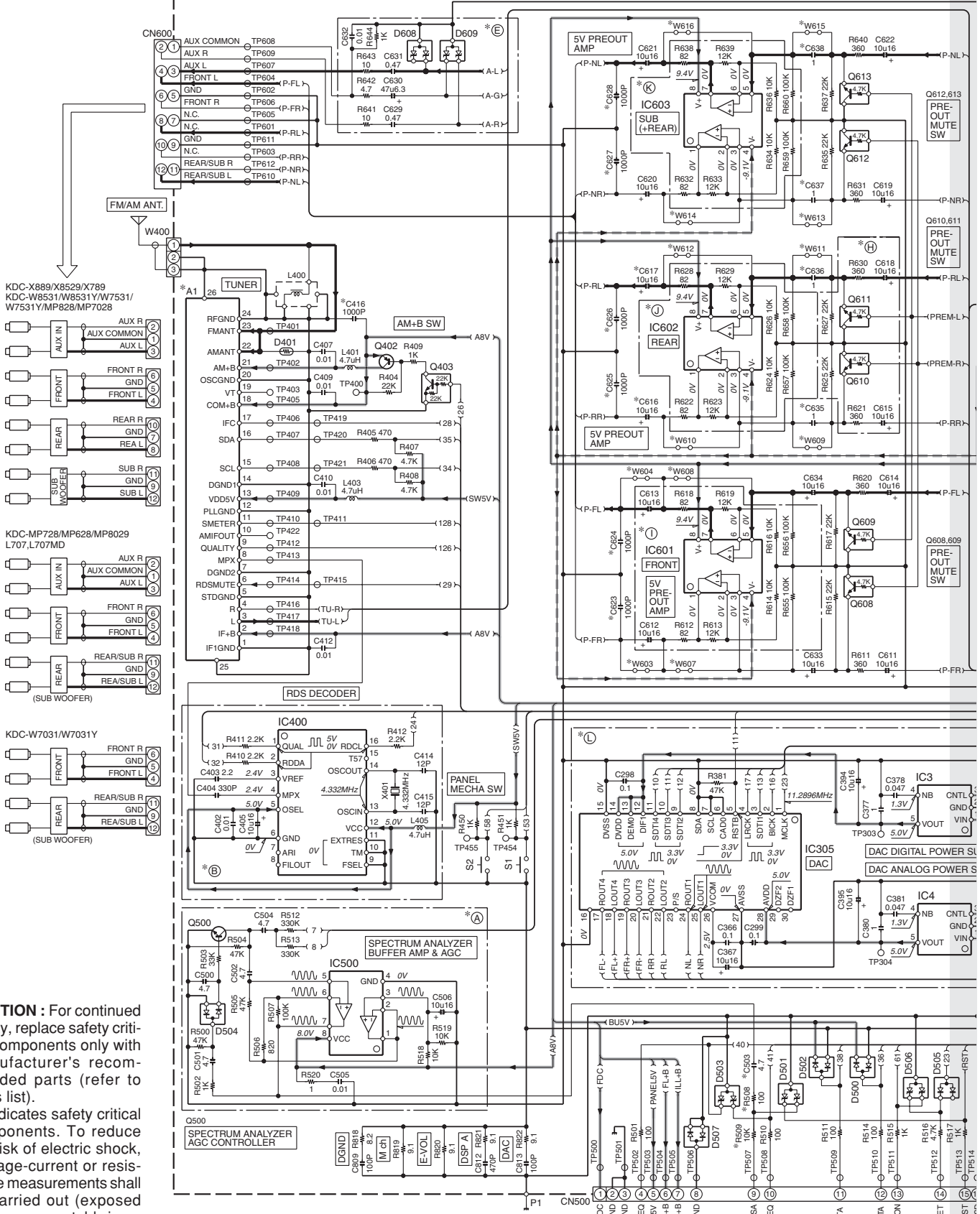

CAUTION : For continued safety, replace safety critical components only with manufacturer's recommended parts (refer to parts list).

⚠ Indicates safety critical components. To reduce the risk of electric shock, leakage-current or resistance measurements shall be carried out (exposed parts are acceptably insulated from the supply circuit) before the appliance is returned to the customer.

• DC voltages are as measured with a high impedance voltmeter. Values may vary slightly due to variations between individual instruments or/and units.

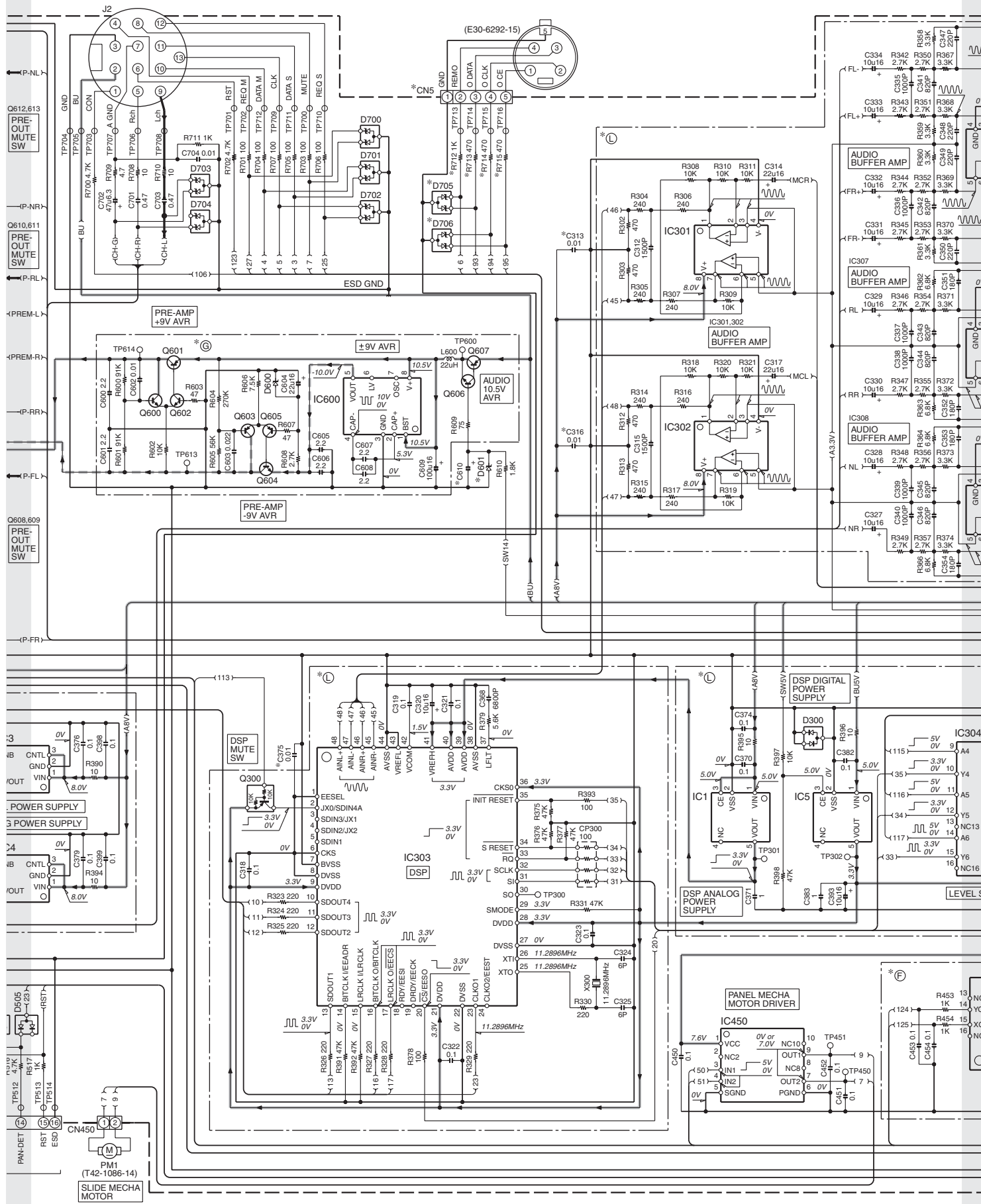

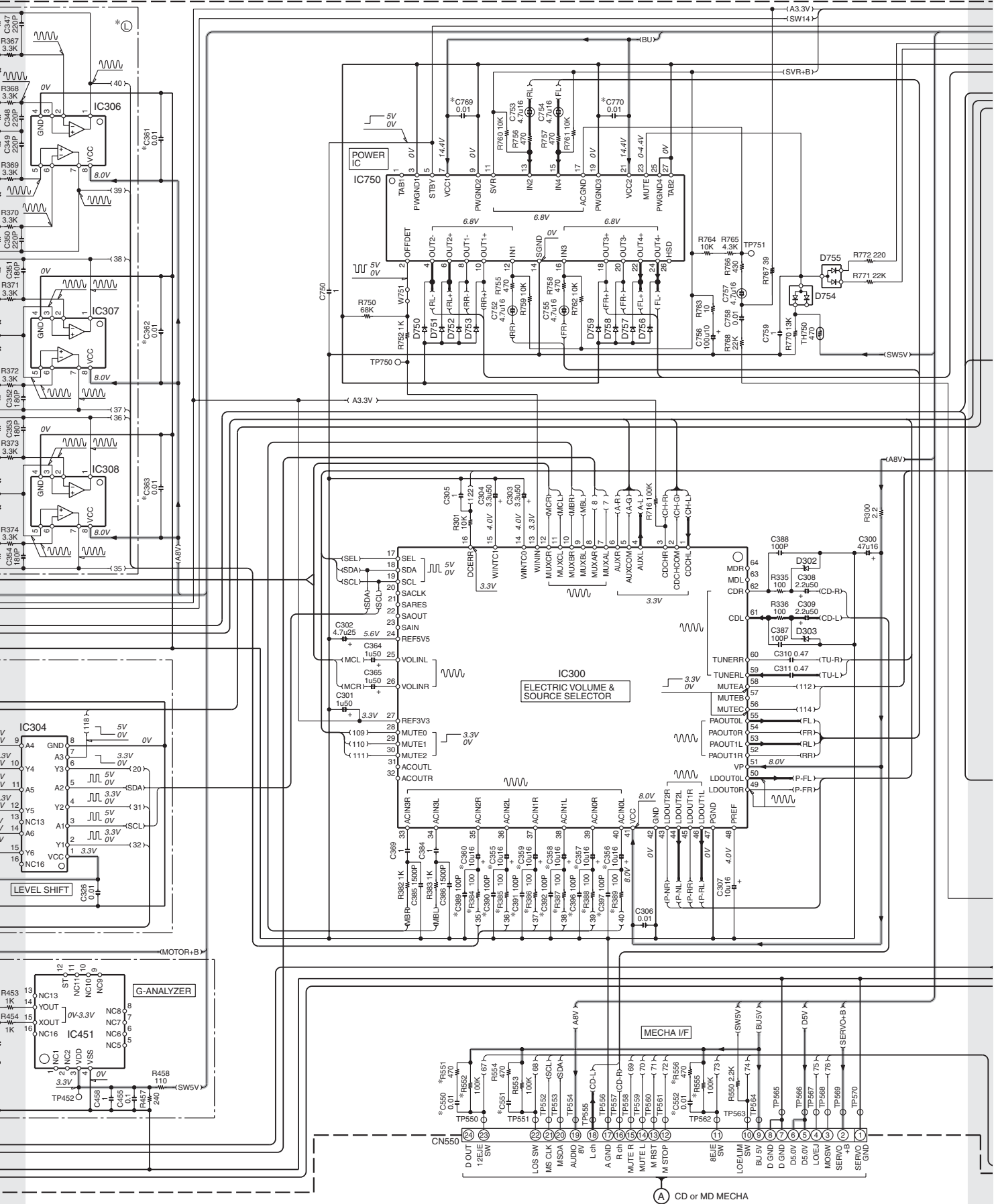

KDC-MP828/W7531/W7531Y/W8531/W8531Y/X789/X8529/X889

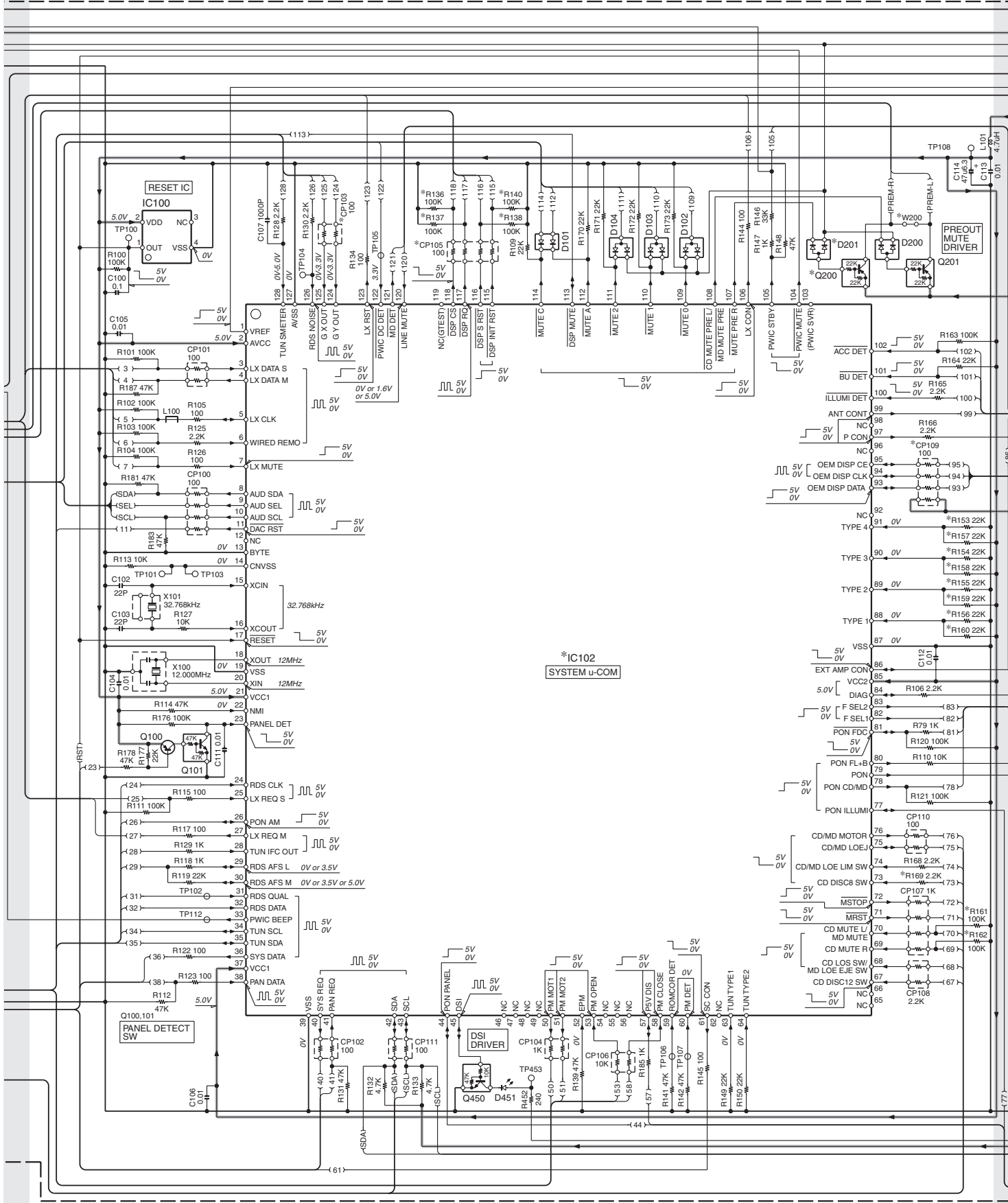

*IC102
SYSTEM u-COM

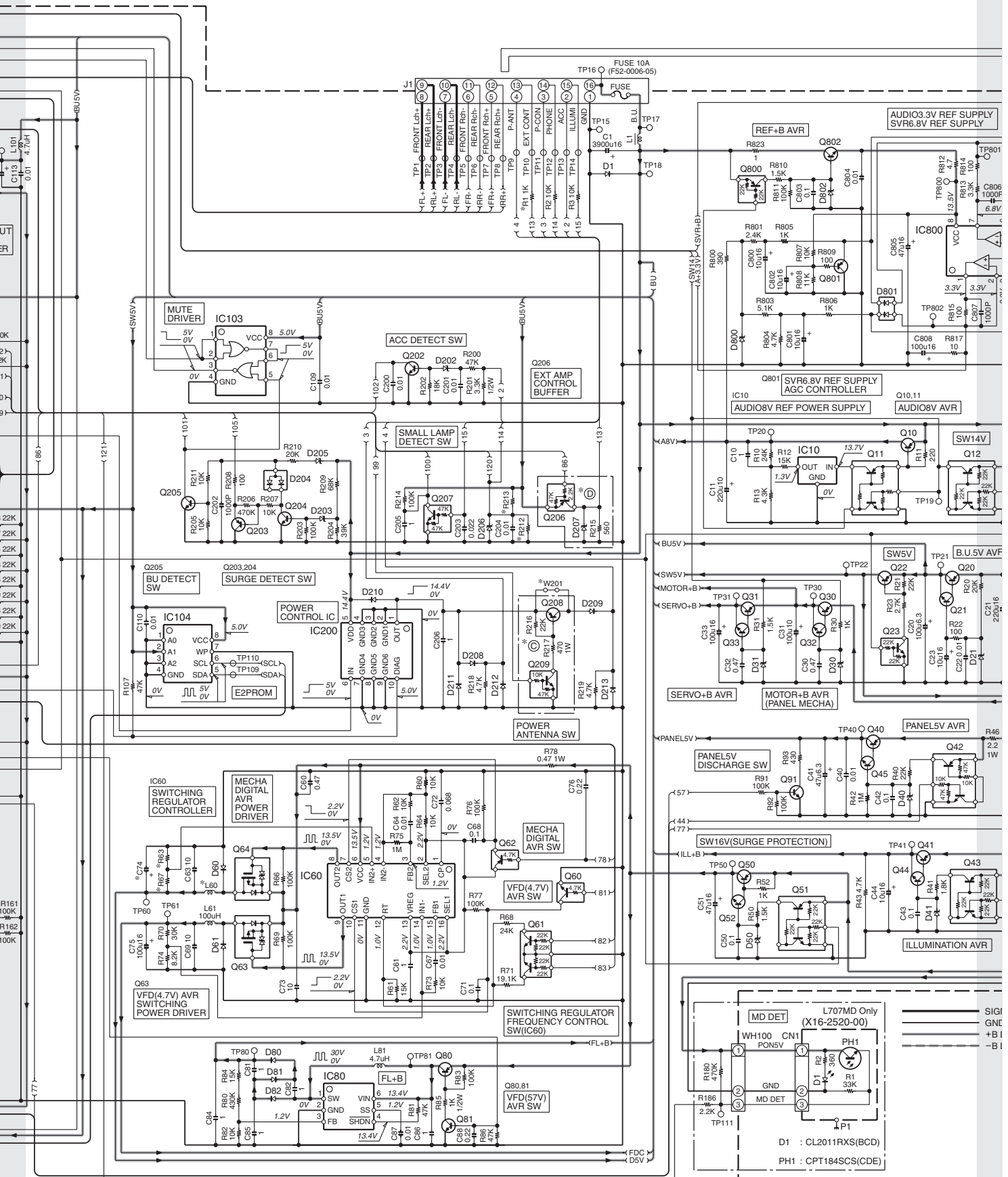

KDC-MP828/W7531/W7531Y/W8531/W8531Y/X789/X8529/X889

KDC-MP828/W7531/W7531Y/W8531/W8531Y/X789/X8529/X889

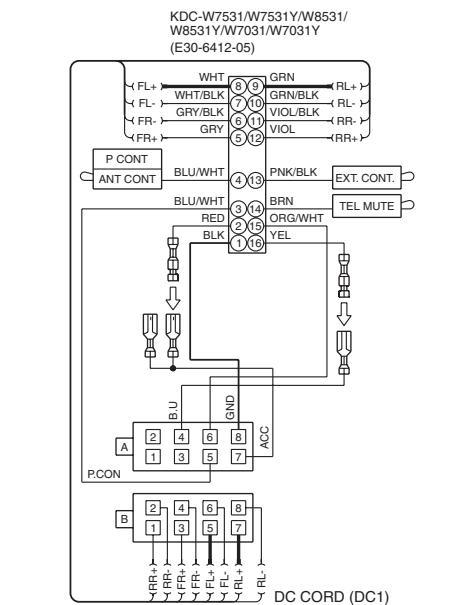
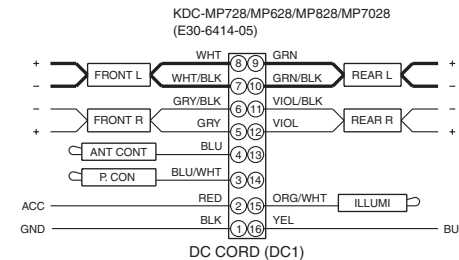
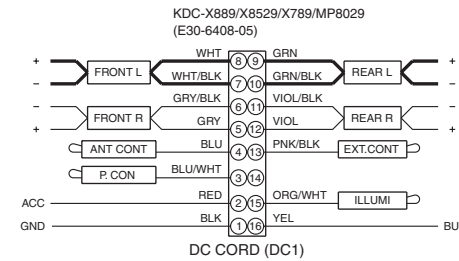
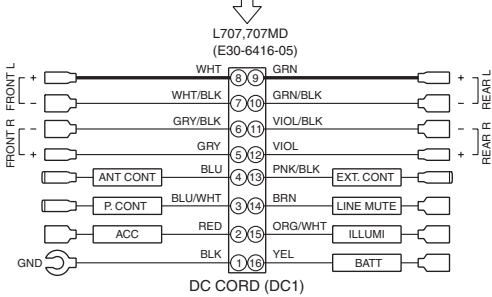
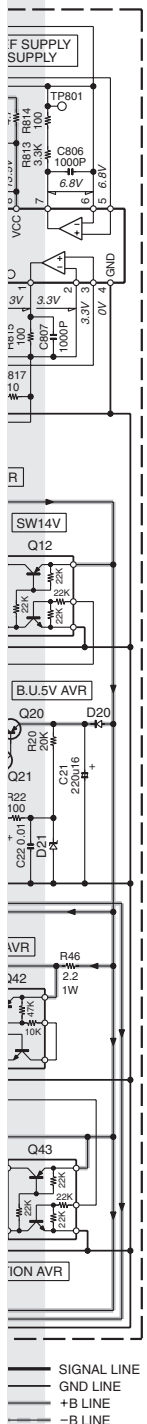

- IC1.5 : XC6204B332MR
- IC3.4 : NJM2864F05-ZB
- IC10 : M5237ML-CF0J
- IC60 : FA3687V
- IC80 : LT3467A
- IC100 : S-80836CENN-B
- IC102 : *
- IC103 : TC7W02FU-F
- IC104 : BR24L04FV-W
- IC200 : TPD1018F-F
- IC300 : E-TDA7415
- IC301,302,306-308,500,800 : RC4580IDR
- IC303 : AK7730A
- IC304 : TC74HC4050AFT
- IC305 : AK5359VF
- IC400 : F-TDA7479AD
- IC450 : LB1930M-F
- IC451 : MMA6261QR2
- IC600 : ICL7660SIBAZ
- IC601-603 : NJM4565V-ZB
- IC750 : E-TDA7570A

- Q10,20,30,40 : 2SB1565
- Q11,12,43,51 : UMC2N
- Q21,45,91 : 2SD2351(W)
- Q22 : 2SA1577
- Q23,403 : DTC124EUA
- Q31 : 2SB1184
- Q32,33,44,52,81,202,204,205,604,606 : 2SC4081
- Q41,607 : 2SB1443
- Q42 : UMD12N
- Q50 : 2SB1449(R)-E
- Q60,608-613 : DTC143TUA
- Q61 : UMG2N
- Q62 : DTA143TUA
- Q63,64 : 2S484-E
- Q80 : 2SB1188(R)
- Q100,203,603,605 : 2SA1576A
- Q101,207 : DTC144EUA
- Q200,201,800 : DTA124EUA
- Q206 : DTA123JK
- Q208 : 2SB1188(Q,R)
- Q209,450 : DTC114YUA
- Q300 : DTA114EUA
- Q402 : 2SC4617
- Q500,600,602 : 2SC4617
- Q601,801 : 2SA1774
- Q802 : 2SC2873-F

- D1 : S2V60+A
- D20 : RB160L-40
- D21,40,207,302,303,600 : UDZS5.6B
- D30 : HZU9.1(B)-E
- D31 : UDZS8.2B
- D4 : HZU11(B)-E
- D50 : HZU16(B)-E
- D60,61 : SFPB-54VN mm
- D80-82 : RB060L-40
- D101,801 : DA227
- D102-104,754,755 : DAP222
- D200,201,204,505 : DAP202U
- D202,203,205,800 : UDZS6.8B
- D206 : UDZS4.7B
- D208-213,750-753 : 1SR154-400
- D451 : B30-1566-05
- D500,502,507 : DA204K
- D501,503,506,700-702,705,706 : STZ6.2N
- D601 : UDZS11B
- D608,609,703,704 : STZ6.8N
- D802 : UDZS16B

MODEL NAME	DEST. NATION	UNIT No.	(A)	(B)	(C)	(D)	(E)	(F)	(G)	(H)	(I)	(J)	(K)	(L)	(M)	(N)	(O)	(P)	(Q)	(R)	(S)	(T)	(U)	(V)	(W)	(X)	(Y)	(Z)
KDC-X889	K	0-10	YES	YES	YES	YES	YES	YES	YES	YES	YES	YES	YES	YES	YES	YES	YES	YES	YES	YES	YES	YES	YES	YES	YES	YES	YES	YES
KDC-MP828	K	0-11	YES	YES	YES	YES	YES	YES	YES	YES	YES	YES	YES	YES	YES	YES	YES	YES	YES	YES	YES	YES	YES	YES	YES	YES	YES	YES
KDC-MP728	K	0-13	YES	YES	YES	YES	YES	YES	YES	YES	YES	YES	YES	YES	YES	YES	YES	YES	YES	YES	YES	YES	YES	YES	YES	YES	YES	YES
KDC-W789	K	0-14	YES	YES	YES	YES	YES	YES	YES	YES	YES	YES	YES	YES	YES	YES	YES	YES	YES	YES	YES	YES	YES	YES	YES	YES	YES	YES
KDC-MP828	K	0-15	YES	YES	YES	YES	YES	YES	YES	YES	YES	YES	YES	YES	YES	YES	YES	YES	YES	YES	YES	YES	YES	YES	YES	YES	YES	YES
KDC-X8529	M	0-21	YES	YES	YES	YES	YES	YES	YES	YES	YES	YES	YES	YES	YES	YES	YES	YES	YES	YES	YES	YES	YES	YES	YES	YES	YES	YES
KDC-MP8029	M	0-22	YES	YES	YES	YES	YES	YES	YES	YES	YES	YES	YES	YES	YES	YES	YES	YES	YES	YES	YES	YES	YES	YES	YES	YES	YES	YES
L707	J	0-01	YES	YES	YES	YES	YES	YES	YES	YES	YES	YES	YES	YES	YES	YES	YES	YES	YES	YES	YES	YES	YES	YES	YES	YES	YES	YES
L707MD	J	0-02	YES	YES	YES	YES	YES	YES	YES	YES	YES	YES	YES	YES	YES	YES	YES	YES	YES	YES	YES	YES	YES	YES	YES	YES	YES	YES

MODEL NAME	DEST. NATION	UNIT No.	(A)	(B)	(C)	(D)	(E)	(F)	(G)	(H)	(I)	(J)	(K)	(L)	(M)	(N)	(O)	(P)	(Q)	(R)	(S)	(T)	(U)	(V)	(W)	(X)	(Y)	(Z)
KDC-X889	K	0-10	YES	YES	YES	YES	YES	YES	YES	YES	YES	YES	YES	YES	YES	YES	YES	YES	YES	YES	YES	YES	YES	YES	YES	YES	YES	YES
KDC-MP828	K	0-11	YES	YES	YES	YES	YES	YES	YES	YES	YES	YES	YES	YES	YES	YES	YES	YES	YES	YES	YES	YES	YES	YES	YES	YES	YES	YES
KDC-MP728	K	0-13	YES	YES	YES	YES	YES	YES	YES	YES	YES	YES	YES	YES	YES	YES	YES	YES	YES	YES	YES	YES	YES	YES	YES	YES	YES	YES
KDC-W789	K	0-14	YES	YES	YES	YES	YES	YES	YES	YES	YES	YES	YES	YES	YES	YES	YES	YES	YES	YES	YES	YES	YES	YES	YES	YES	YES	YES
KDC-MP828	K	0-15	YES	YES	YES	YES	YES	YES	YES	YES	YES	YES	YES	YES	YES	YES	YES	YES	YES	YES	YES	YES	YES	YES	YES	YES	YES	YES
KDC-X8529	M	0-21	YES	YES	YES	YES	YES	YES	YES	YES	YES	YES	YES	YES	YES	YES	YES	YES	YES	YES	YES	YES	YES	YES	YES	YES	YES	YES
KDC-MP8029	M	0-22	YES	YES	YES	YES	YES	YES	YES	YES	YES	YES	YES	YES	YES	YES	YES	YES	YES	YES	YES	YES	YES	YES	YES	YES	YES	YES
L707	J	0-01	YES	YES	YES	YES	YES	YES	YES	YES	YES	YES	YES	YES	YES	YES	YES	YES	YES	YES	YES	YES	YES	YES	YES	YES	YES	YES
L707MD	J	0-02	YES	YES	YES	YES	YES	YES	YES	YES	YES	YES	YES	YES	YES	YES	YES	YES	YES	YES	YES	YES	YES	YES	YES	YES	YES	YES

MODEL NAME	DEST. NATION	UNIT No.	(A)	(B)	(C)	(D)	(E)	(F)	(G)	(H)	(I)	(J)	(K)	(L)	(M)	(N)	(O)	(P)	(Q)	(R)	(S)	(T)	(U)	(V)	(W)	(X)	(Y)	(Z)
KDC-W8531Y	E	2-70	YES	YES	YES	YES	YES	YES	YES	YES	YES	YES	YES	YES	YES	YES	YES	YES	YES	YES	YES	YES	YES	YES	YES	YES	YES	YES
KDC-W7531Y	E	2-71	YES	YES	YES	YES	YES	YES	YES	YES	YES	YES	YES	YES	YES	YES	YES	YES	YES	YES	YES	YES	YES	YES	YES	YES	YES	YES
KDC-W7031Y	E	2-72	YES	YES	YES	YES	YES	YES	YES	YES	YES	YES	YES	YES	YES	YES	YES	YES	YES	YES	YES	YES	YES	YES	YES	YES	YES	YES

MODEL NAME	DEST. NATION	UNIT No.	(A)	(B)	(C)	(D)	(E)	(F)	(G)	(H)	(I)	(J)	(K)	(L)	(M)	(N)	(O)	(P)	(Q)	(R)	(S)	(T)	(U)	(V)	(W)	(X)	(Y)	(Z)
KDC-W8531Y	E	2-70	YES	YES	YES	YES	YES	YES	YES	YES	YES	YES	YES	YES	YES	YES	YES	YES	YES	YES	YES	YES	YES	YES	YES	YES	YES	YES
KDC-W7531Y	E	2-71	YES	YES	YES	YES	YES	YES	YES	YES	YES	YES	YES	YES	YES	YES	YES	YES	YES	YES	YES	YES	YES	YES	YES	YES	YES	YES
KDC-W7031Y	E	2-72	YES	YES	YES	YES	YES	YES	YES	YES	YES	YES	YES	YES	YES	YES	YES	YES	YES	YES	YES	YES	YES	YES	YES	YES	YES	YES

MODEL NAME	DEST. NATION	UNIT No.	(A)	(B)	(C)	(D)	(E)	(F)	(G)	(H)	(I)	(J)	(K)	(L)	(M)	(N)	(O)	(P)	(Q)	(R)	(S)	(T)	(U)	(V)	(W)	(X)	(Y)	(Z)
KDC-W7531	E	2-71	YES	YES	YES	YES	YES	YES	YES	YES	YES	YES	YES	YES	YES	YES	YES	YES	YES	YES	YES	YES	YES	YES	YES	YES	YES	YES
KDC-W7031	E	2-72	YES	YES	YES	YES	YES	YES	YES	YES	YES	YES	YES	YES	YES	YES	YES	YES	YES	YES	YES	YES	YES	YES	YES	YES	YES	YES

Y/X789/X8529/X889 (1/2)

KDC-MP828/W7531/W7531Y/W8531 /W8531Y/X789/X8529/X889

SWITCH UNIT (X16-xxxx-xx)

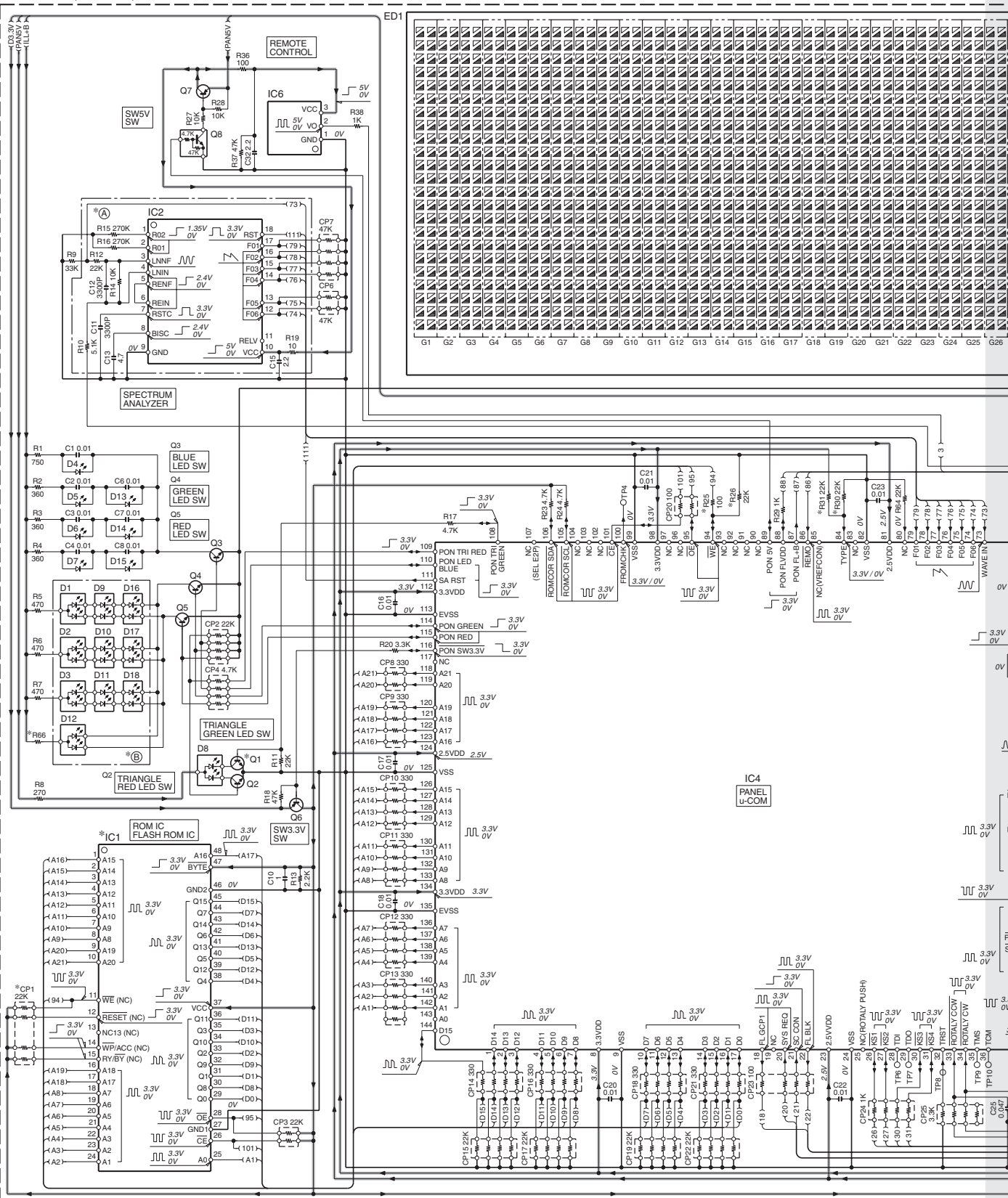

CAUTION : For continued safety, replace safety critical components only with manufacturer's recommended parts (refer to parts list).

⚠ Indicates safety critical components. To reduce the risk of electric shock, leakage-current or resistance measurements shall be carried out (exposed parts are acceptably insulated from the supply circuit) before the appliance is returned to the customer.

128X23 Pixels/2 Colors

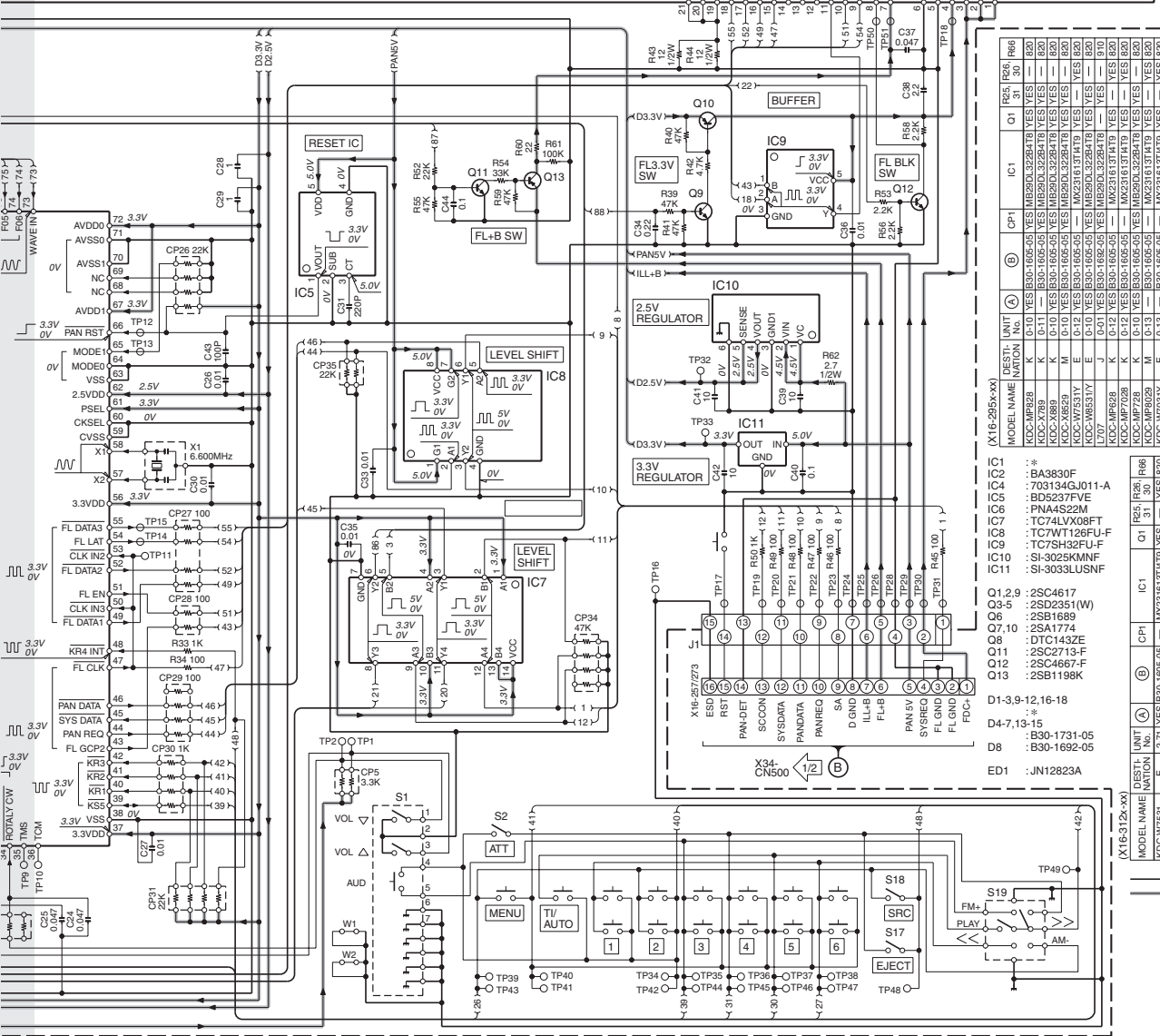
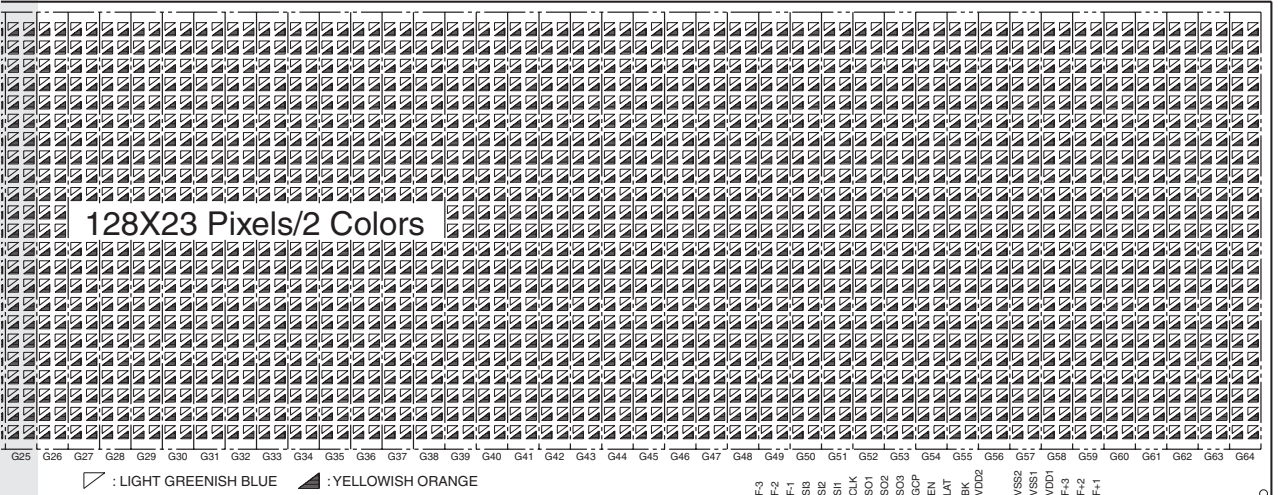

MODEL NAME	DESTINATION	UNIT No.	IC1	IC2	IC3	IC4	IC5	IC6	IC7	IC8	IC9	IC10	IC11	Q1,2,9	Q3-5	Q6	Q7,10	Q11	Q12	Q13	D1-3,9,12,16-18	D4-7,13-15	D8	ED1	
KDC-MP828	K	0-10	YES	B30-1692-05	YES	MB92DL3224T18	YES	YES	YES	YES	YES	YES	YES	YES	YES	YES	YES	YES	YES	YES	YES	YES	YES	YES	YES
KDC-X789	K	0-10	YES	B30-1692-05	YES	MB92DL3224T18	YES	YES	YES	YES	YES	YES	YES	YES	YES	YES	YES	YES	YES	YES	YES	YES	YES	YES	YES
KDC-X829	M	0-12	YES	B30-1692-05	YES	MB92DL3224T18	YES	YES	YES	YES	YES	YES	YES	YES	YES	YES	YES	YES	YES	YES	YES	YES	YES	YES	YES
KDC-W7531Y	E	0-10	YES	B30-1692-05	YES	MB92DL3224T18	YES	YES	YES	YES	YES	YES	YES	YES	YES	YES	YES	YES	YES	YES	YES	YES	YES	YES	YES
KDC-W8531Y	J	0-10	YES	B30-1692-05	YES	MB92DL3224T18	YES	YES	YES	YES	YES	YES	YES	YES	YES	YES	YES	YES	YES	YES	YES	YES	YES	YES	YES
KDC-MP728	K	0-10	YES	B30-1692-05	YES	MB92DL3224T18	YES	YES	YES	YES	YES	YES	YES	YES	YES	YES	YES	YES	YES	YES	YES	YES	YES	YES	YES
KDC-MP728	K	0-10	YES	B30-1692-05	YES	MB92DL3224T18	YES	YES	YES	YES	YES	YES	YES	YES	YES	YES	YES	YES	YES	YES	YES	YES	YES	YES	YES
KDC-MP7031Y	E	0-13	YES	B30-1692-05	YES	MB92DL3224T18	YES	YES	YES	YES	YES	YES	YES	YES	YES	YES	YES	YES	YES	YES	YES	YES	YES	YES	YES
KDC-W7031	E	2-21	YES	B30-1692-05	YES	MB92DL3224T18	YES	YES	YES	YES	YES	YES	YES	YES	YES	YES	YES	YES	YES	YES	YES	YES	YES	YES	YES

• DC voltages are as measured with a high impedance voltmeter. Values may vary slightly due to variations between individual instruments or/and units.

KDC-MP828/W7531/W7531Y/W8531
/W8531Y/X789/X8529/X889

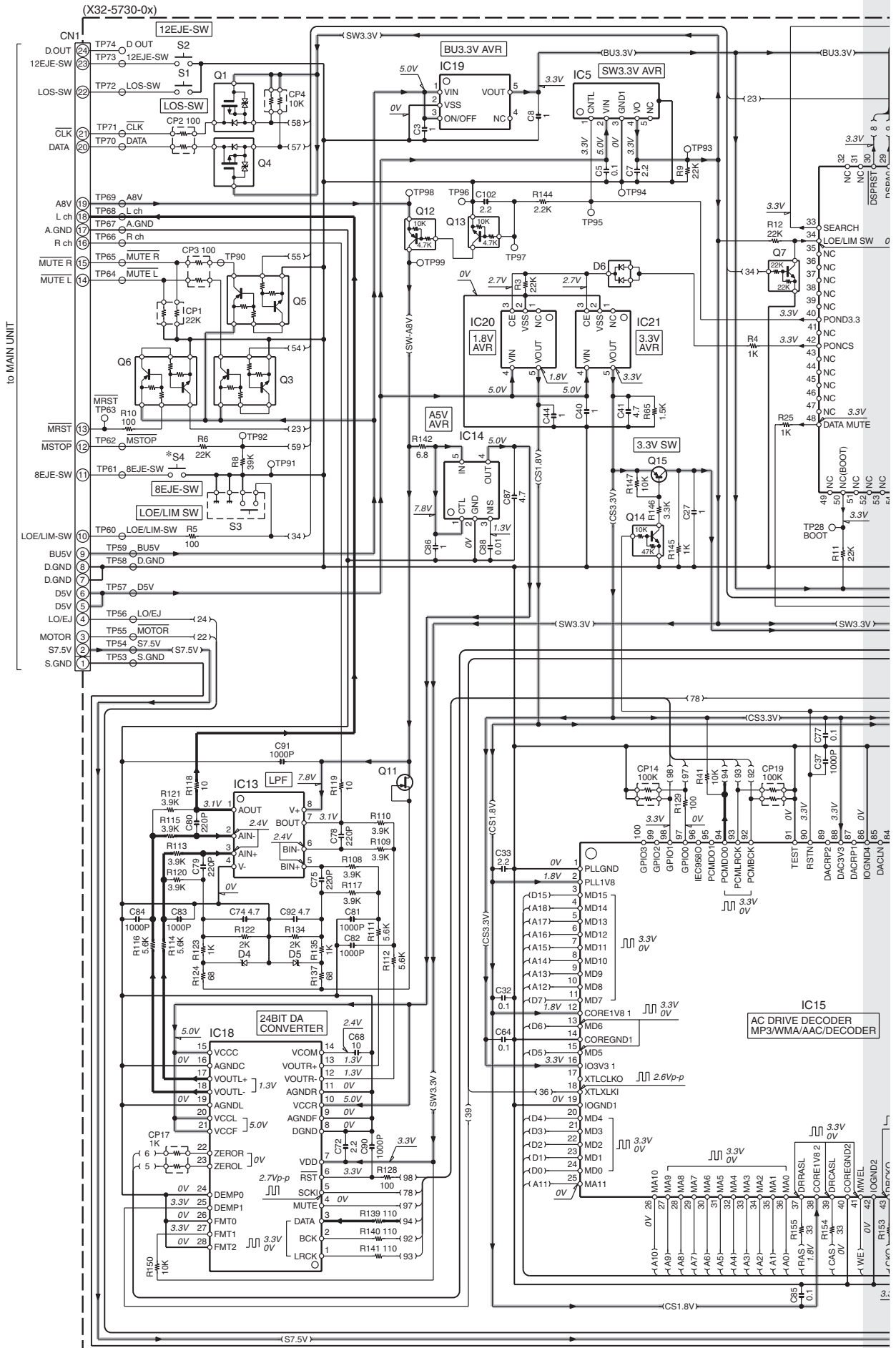

KDC-MP828/W7531/W7531Y/W8531/W8531Y/X789/X8529/X889

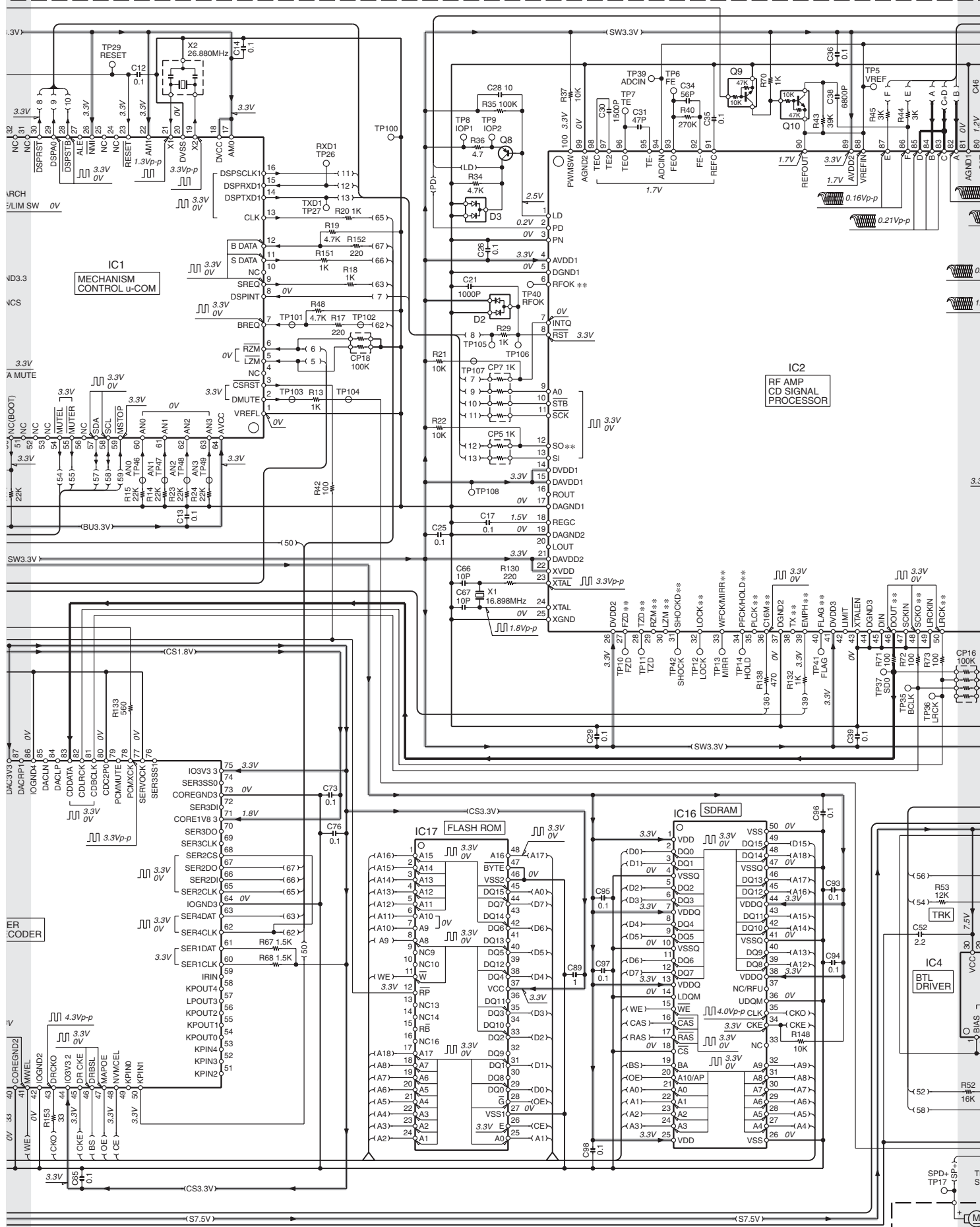

KDC-MP828/W7531/W7531Y/W8531/W8531Y/X789/X8529/X889

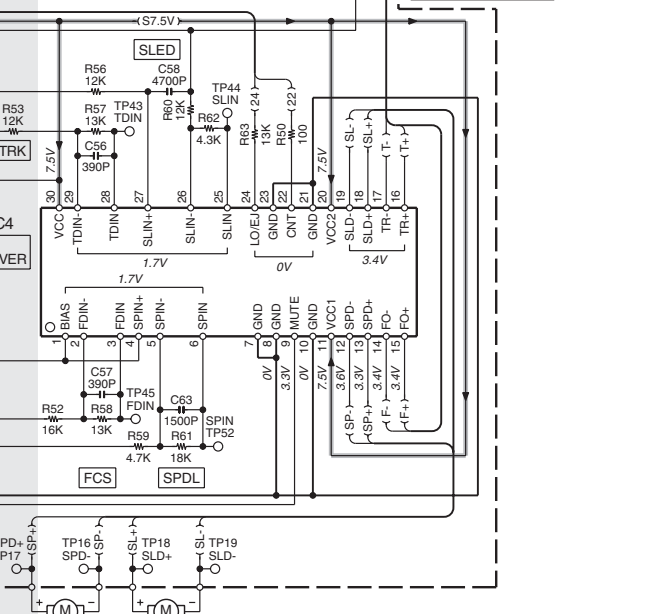
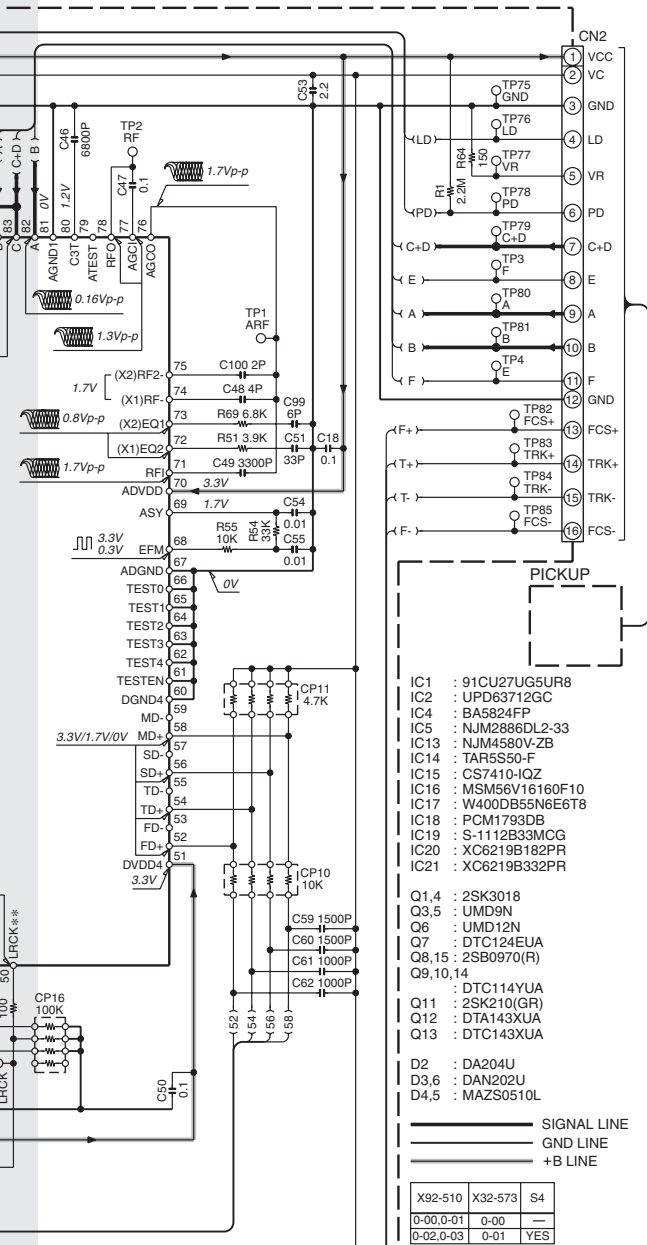

2SB1565

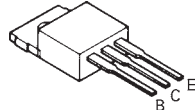

- DTA123JK
- DTC114YUA
- DTC143TUA
- DTC143ZE
- 2SA1576A
- 2SC2713-F
- 2SC4617



2SB1188

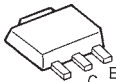

2SC2873-F

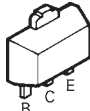

2SB1184

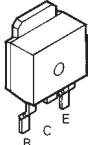

2SB1443

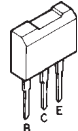

2SA1774

2SC4081

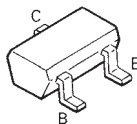

- DTA114EUA
- DTA124EUA
- DTA143TUA
- DTC124EUA
- DTC144EUA

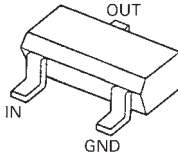

UMC2N

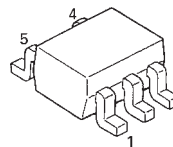

DAN202U



- DAP202U
- DA204K
- DA204U



2SK210



DA227

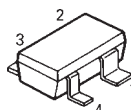

2SJ484-E



BA3830F

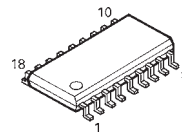

M5237ML-CF0J

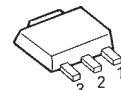

NJM4580V-ZB

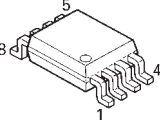

LB1930M-E

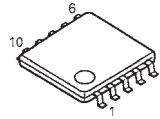

TC74HC4050AFT

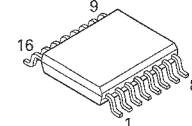

TC7SH32FU-F

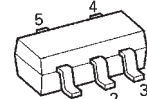

CAUTION : For continued safety, replace safety critical components only with manufacturer's recommended parts (refer to parts list).

⚠ Indicates safety critical components. To reduce the risk of electric shock, leakage-current or resistance measurements shall be carried out (exposed parts are acceptably insulated from the supply circuit) before the appliance is returned to the customer.

• DC voltages are as measured with a high impedance voltmeter. Values may vary slightly due to variations between individual instruments or/and units.

1
2
3
4
5
6
7

EXPLODED VIEW (CD MECHANISM)

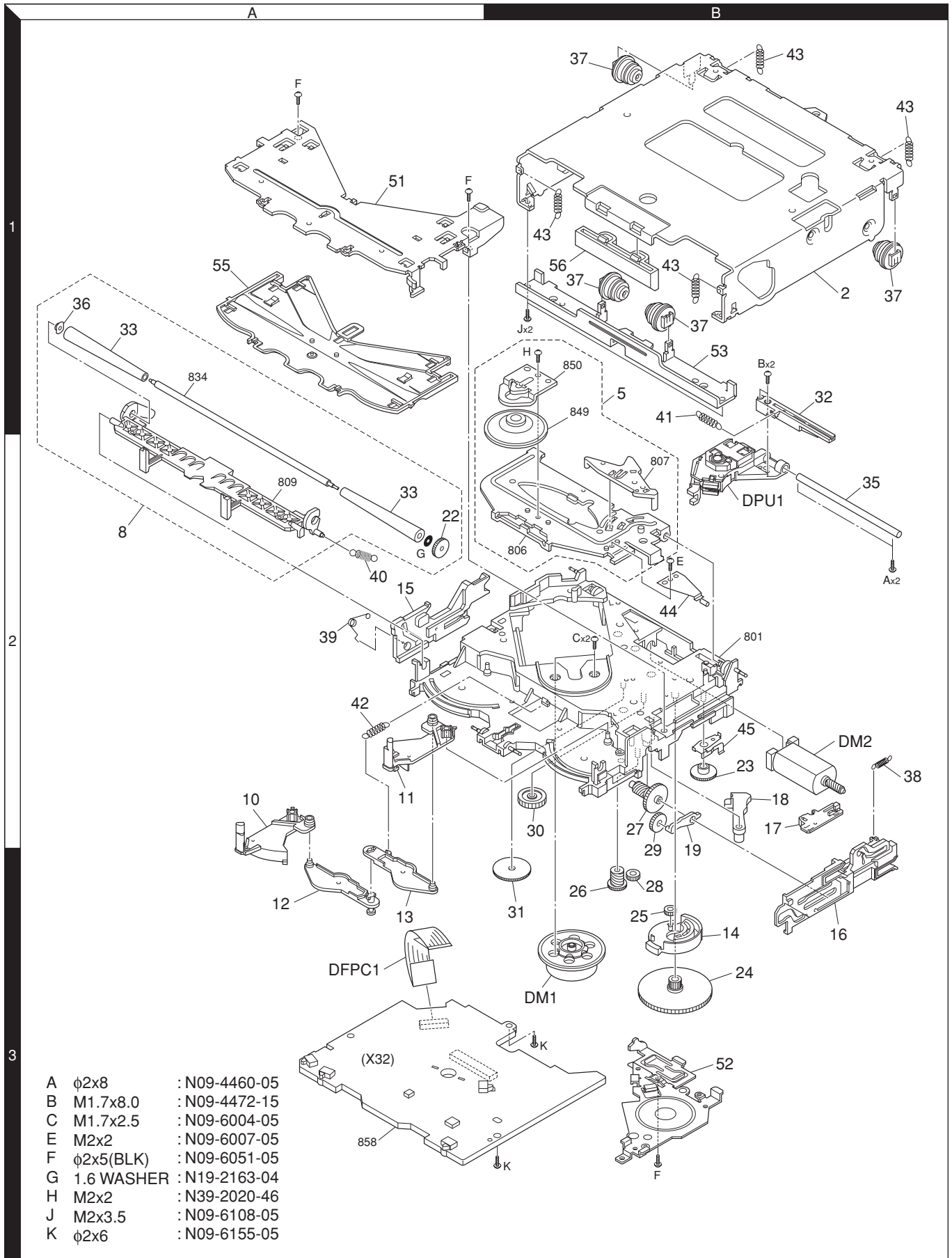

Parts with the exploded numbers larger than 700 are not supplied.

EXPLODED VIEW (UNIT)

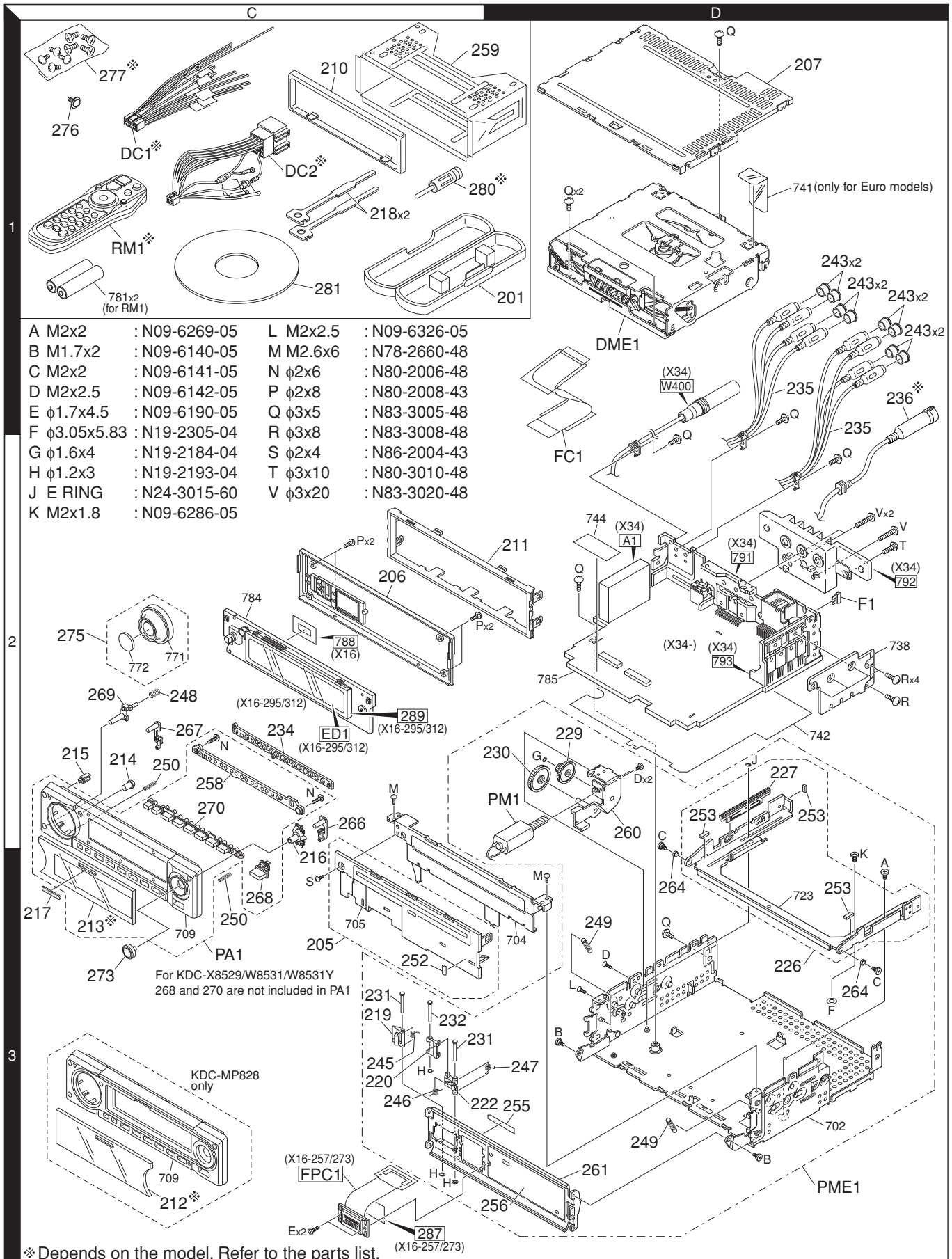

PARTS LIST

* New parts

Parts without **Parts No.** are not supplied.

Les articles non mentionnés dans le **Parts No.** ne sont pas fournis.

Teile ohne **Parts No.** werden nicht geliefert.

Ref. No.	A d d	N e w	Parts No.	Description	Desti- nation	Ref. No.	A d d	N e w	Parts No.	Description	Desti- nation
KDC-MP828/W7531/W7531Y/W8531/W8531Y/X789/X8529/X889						214	2C	*	B10-4714-04	FRONT GLASS	KK1M1
201	1C		A02-2732-03	PLASTIC CABINET ASSY		215	2C	*	B19-2309-03	LIGHTING BOARD	
205	3C		A22-3023-12	SUB PANEL ASSY		216	2C	*	B19-2310-03	LIGHTING BOARD	
206	2C	*	A46-1817-01	REAR COVER		217	3C		B43-1518-04	BADGE	
207	1D		A52-0845-12	TOP PLATE		218	1C		D10-4589-04	LEVER	
PA1	3C	*	A64-3495-12	PANEL ASSY	K	219	3C		D10-4805-03	LEVER	
PA1	3C	*	A64-3496-12	PANEL ASSY	E2E4	220	3C		D10-4806-03	LEVER	
PA1	3C	*	A64-3497-12	PANEL ASSY	K1	222	3C		D10-4807-13	LEVER	
PA1	3C	*	A64-3499-12	PANEL ASSY	E1E3	226	3D	*	D10-4875-13	SLIDER ASSY	
PA1	3C	*	A64-3500-12	PANEL ASSY	M1	227	2D		D13-2318-13	RACK (GEAR)	
PA1	3C	*	A64-3504-12	PANEL ASSY	K2	229	2D		D13-2320-04	GEAR	
PME1	3D	*	A10-5205-22	CHASSIS ASSY	E1E2E3	230	2D		D13-2321-04	GEAR	
PME1	3D	*	A10-5205-22	CHASSIS ASSY	KK1M1	231	3C		D21-2442-04	SHAFT	
PME1	3D	*	A10-5205-22	CHASSIS ASSY	K2	232	3C		D21-2443-04	SHAFT	
PME1	3D	*	A10-5224-22	CHASSIS ASSY	E4	234	2C	*	E29-2026-03	CONDUCTIVE RUBBER	
RM1	1C	*	A70-2067-05	REMOTE CONTROLLER ASSY (RC-527)	E1E3K2	235	2D	*	E30-6435-05	CORD WITH PINPLUG (GOLD)	KK1M1
RM1	1C	*	A70-2067-05	REMOTE CONTROLLER ASSY (RC-527)	KK1M1	235	1D	*	E30-6436-05	CORD WITH PINPLUG (NICKEL)	E1E2E3
-			B46-0100-50	WARRANTY CARD	E1K2E4	235	1D	*	E30-6436-05	CORD WITH PINPLUG (NICKEL)	K2E4
-			B46-0100-50	WARRANTY CARD	KK1M1	236	1D	*	E30-6292-15	CORD WITH DIN CONNECTOR	E1E2E3
-			B46-0606-04	ID CARD	KK1K2	236	1D	*	E30-6292-15	CORD WITH DIN CONNECTOR	E4
-			B46-0612-14	ID CARD	E3E4	DC1	1C	*	E30-6408-05	DC CORD	KK1M1
-			B46-0612-14	ID CARD	M1E1E2	DC1	1C	*	E30-6414-05	DC CORD	K2
-			B46-0612-14	ID CARD		DC2	1C	*	E30-6412-05	DC CORD	E1E2E3
-			B46-0612-14	ID CARD		DC2	1C	*	E30-6412-05	DC CORD	E4
-			B46-0648-13	USER CARD	KK1	FC1	2D		E39-0736-05	FLAT CABLE	
-			B58-1426-04	CAUTION CARD	KK1K2	FC1	2D		E39-0736-05	FLAT CABLE	
-		*	B59-1832-00	SUB-INSTRUCTION MANUAL	E2E3	243	1D		F29-0626-04	INSULATING COVER	
-		*	B59-1832-00	SUB-INSTRUCTION MANUAL	KK1M1	F1	2D		F52-0006-05	FUSE (MINI BLADE TYPE) (10A)	
-		*	B59-1832-00	SUB-INSTRUCTION MANUAL	K2	245	3C		G01-3210-04	TORSION COIL SPRING	
-		*	B64-2962-10	INST. MANUAL (ENGLISH)	E1E4	246	3C		G01-3211-04	TORSION COIL SPRING	
-		*	B64-2963-10	INST. MANUAL (FRE, SPA)	KK1K2	247	3D		G01-3212-04	TORSION COIL SPRING	
-		*	B64-2964-00	INST. MANUAL (ENG, T-CHI)	M1	248	2C		G01-3213-04	COMPRESSION SPRING	
-		*	B64-2966-10	INST. MANUAL (ENG, RUS)	E2E3	249	3D		G01-3215-04	EXTENSION SPRING	
-		*	B64-2987-10	INST. MANUAL (ENGLISH)	E1E4	250	3C	*	G01-3261-04	COMPRESSION SPRING	
-		*	B64-2988-00	INST. MANUAL (FRE, GER)	E4	252	3C	*	G11-3594-04	CUSHION	
-		*	B64-2988-10	INST. MANUAL (FRE, GER)	E1	253	2D	*	G11-3646-04	CUSHION	
-		*	B64-2989-00	INST. MANUAL (DUT, ITA)	E4	255	3D		G16-1482-14	SHEET	
-		*	B64-2989-10	INST. MANUAL (DUT, ITA)	E1	256	3D		G16-1483-04	SHEET	
-		*	B64-2990-00	INST. MANUAL (SPA, POR)	E4	-		*	H10-4925-02	POLYSTYRENE FOAMED FIXTURE	E1E2E3
-		*	B64-2990-10	INST. MANUAL (SPA, POR)	E1	-		*	H10-4925-02	POLYSTYRENE FOAMED FIXTURE	KK1M1
210	1C	*	B07-3125-01	ESCUTCHEON	E1E2E3	-		*	H10-4925-02	POLYSTYRENE FOAMED FIXTURE	K2
210	1C	*	B07-3125-01	ESCUTCHEON	E4	-		*	H10-4933-02	POLYSTYRENE FOAMED FIXTURE	E4
210	1C	*	B07-3125-01	ESCUTCHEON	KK1M1	-		*	H25-0329-04	PROTECTION BAG (280X450X0.03)	E2E3K2
210	1C	*	B07-3126-01	ESCUTCHEON	K2	-			H25-0329-04	PROTECTION BAG (280X450X0.03)	KK1M1
211	2C		B07-3095-02	ESCUTCHEON		-			H25-0337-04	PROTECTION BAG (180X300X0.03)	
212	3C	*	B10-4651-11	FRONT GLASS	K2	-			H25-1111-04	PROTECTION BAG (280X450X0.03)	E1E4
213	3C	*	B10-4642-11	FRONT GLASS	K	-		*	H54-3332-03	ITEM CARTON CASE (KDC-X889)	K
213	3C	*	B10-4643-11	FRONT GLASS	E2E4	-		*	H54-3333-03	ITEM CARTON CASE (KDC-X789)	K1
213	3C	*	B10-4644-11	FRONT GLASS	K1	-		*	H54-3335-03	ITEM CARTON CASE (KDC-W8531Y)	E3
213	3C	*	B10-4646-11	FRONT GLASS	E1E3	-		*	H54-3337-03	ITEM CARTON CASE (KDC-W7531Y)	E2
213	3C	*	B10-4647-11	FRONT GLASS	M1	-		*	H54-3338-03	ITEM CARTON CASE (KDC-X8529)	M1
214	2C	*	B10-4662-04	FRONT GLASS	K2	-		*	H54-3341-03	ITEM CARTON CASE (KDC-MP828)	K2
214	2C	*	B10-4714-04	FRONT GLASS	E1E2E3	-		*	H54-3391-03	ITEM CARTON CASE (KDC-W8531)	E1
214	2C	*	B10-4714-04	FRONT GLASS	E4	-		*	H54-3392-03	ITEM CARTON CASE (KDC-W7531)	E4

E1 : KDC-W8531 E2 : KDC-W7531Y E3 : KDC-W8531Y E4 : KDC-W7531
K : KDC-X889 K1 : KDC-X789 K2 : KDC-MP828 M1 : KDC-X8529
(E : Europe K : North America M : Other Areas W : Without Europe)

△ Indicates safety critical components.

PARTS LIST

KDC-MP828/W7531/W7531Y/W8531/W8531Y/X789/X8529/X889

Ref. No.	Add	New	Parts No.	Description	Destination
258	2C	*	J19-7053-02	HOLDER	
259	1C		J21-9716-03	MOUNTING HARDWARE ASSY	
260	2D		J22-0114-03	MOUNTING HARDWARE ASSY	
261	3D	*	J22-0263-02	MOUNTING HARDWARE	
264	3D		J31-1062-04	COLLAR	
266	2C	*	K24-4286-03	PUSH KNOB (EJECT)	E1E2E3
266	2C	*	K24-4286-03	PUSH KNOB (EJECT)	E4
266	2C	*	K24-4286-03	PUSH KNOB (EJECT)	KK1M1
266	2C	*	K24-4288-03	PUSH KNOB (EJECT)	K2
267	2C	*	K24-4289-03	PUSH KNOB (ATT)	E1E2E3
267	2C	*	K24-4289-03	PUSH KNOB (ATT)	E4
267	2C	*	K24-4289-03	PUSH KNOB (ATT)	KK1M1
267	2C	*	K24-4291-03	PUSH KNOB (ATT)	K2
268	3C	*	K24-4292-03	PUSH KNOB (SRC)	E1E2E3
268	3C	*	K24-4292-03	PUSH KNOB (SRC)	E4
268	3C	*	K24-4292-03	PUSH KNOB (SRC)	KK1M1
268	3C	*	K24-4294-03	PUSH KNOB (SRC)	K2
269	2C	*	K24-4295-03	PUSH KNOB (RELEASE)	E1E2E3
269	2C	*	K24-4295-03	PUSH KNOB (RELEASE)	E4
269	2C	*	K24-4295-03	PUSH KNOB (RELEASE)	KK1M1
269	2C	*	K24-4297-03	PUSH KNOB (RELEASE)	K2
270	2C	*	K25-1695-02	PUSH KNOB (PRESET)	E1E2E3
270	2C	*	K25-1695-02	PUSH KNOB (PRESET)	E4
270	2C	*	K25-1695-02	PUSH KNOB (PRESET)	KK1M1
270	2C	*	K25-1696-02	PUSH KNOB (PRESET)	K2
273	3C	*	K29-7144-03	KEY TOP (FM/AM, SEEK)	
275	2C	*	K29-7150-04	KNOB ASSY (VOL)	
276	1C	*	N09-6212-05	TAPPING SCREW	KK1K2
276	1C	*	N09-6280-05	TAPPING SCREW	E3E4
276	1C	*	N09-6280-05	TAPPING SCREW	M1E1E2
277	1C		N99-1723-05	SCREW SET	KK1K2
277	1C		N99-1758-05	SCREW SET	M1
A	3D	*	N09-6269-05	STEPPED SCREW	
B	3D		N09-6140-05	STEPPED SCREW	
C	3D		N09-6141-05	STEPPED SCREW	
D	2D		N09-6142-05	MACHINE SCREW	
E	3C		N09-6190-05	TAPPING SCREW	
F	3D	*	N19-2305-04	FLAT WASHER	
G	2D		N19-2184-04	FLAT WASHER	
H	3C		N19-2193-04	FLAT WASHER	
J	2D		N24-3015-60	E TYPE RETAINING RING	
K	3D	*	N09-6286-05	STEPPED SCREW	
L	3D	*	N09-6326-05	MACHINE SCREW	
M	2C	*	N78-2660-48	PAN HEAD TAPTITE SCREW	
N	2C		N80-2006-48	PAN HEAD TAPTITE SCREW	
P	2C		N80-2008-43	PAN HEAD TAPTITE SCREW	
Q	1D		N83-3005-48	PAN HEAD TAPTITE SCREW	
R	2D		N83-3008-48	PAN HEAD TAPTITE SCREW	
S	3C	*	N86-2004-43	BINDING HEAD TAPTITE SCREW	
280	1C		T90-0523-05	ANTENNA ADAPTOR	E1E2E3
280	1C		T90-0523-05	ANTENNA ADAPTOR	E4
PM1	2D		T42-1086-14	MOTOR ASSY	
281	1C	*	W01-1643-15	COMPACT DISC	KK1M1

Ref. No.	Add	New	Parts No.	Description	Destination
281	1C	*	W01-1643-15	COMPACT DISC	K2
281	1C	*	W01-1647-05	COMPACT DISC	E1E2E3
281	1C	*	W01-1647-05	COMPACT DISC	E4
DME1	1D		X92-5100-00	MECHANISM ASSY	
SUB-CIRCUIT UNIT (X16-2570-10 / X16-2732-70)					
287	3C		F20-2284-14	INSULATING SHEET	
FPC1	3C		J86-0003-05	FPC (LEAD FREE)	
SWITCH UNIT (X16-2950-1x / X16-3122-71)					
D1-3			B30-1605-05	LED (2-COLOR, PG/RED)	
D4-7		*	B30-1731-05	LED (BLUE)	
D8			B30-1692-05	LED (HR/YG)	
D9-12			B30-1605-05	LED (2-COLOR, PG/RED)	
D13-15		*	B30-1731-05	LED (BLUE)	
D16-18			B30-1605-05	LED (2-COLOR, PG/RED)	
C1-4			CK73GB1H103K	CHIP C 0.010UF	K
C6-8			CK73GB1H103K	CHIP C 0.010UF	K
C10			CK73GB0J105K	CHIP C 1.0UF	K
C11,12			CK73GB1H332K	CHIP C 3300PF	K
C11,12			CK73GB1H332K	CHIP C 3300PF	K
C11,12			CK73GB1H332K	CHIP C 3300PF	K
C13			CK73EB1A475K	CHIP C 4.7UF	K
C13			CK73EB1A475K	CHIP C 4.7UF	K
C13			CK73EB1A475K	CHIP C 4.7UF	K
C15			CK73FB1A225K	CHIP C 2.2UF	K
C15			CK73FB1A225K	CHIP C 2.2UF	K
C15			CK73FB1A225K	CHIP C 2.2UF	K
C16-18			CK73GB1H103K	CHIP C 0.010UF	K
C20-23			CK73GB1H103K	CHIP C 0.010UF	K
C24,25			CK73GB1E473K	CHIP C 0.047UF	K
C26,27			CK73GB1H103K	CHIP C 0.010UF	K
C28,29			CK73GB0J105K	CHIP C 1.0UF	K
C30			CK73GB1H103K	CHIP C 0.010UF	K
C31			CC73GCH1H221J	CHIP C 220PF	J
C32			CK73FB1A225K	CHIP C 2.2UF	K
C33			CK73GB1H103K	CHIP C 0.010UF	K
C34			CK73GB1A224K	CHIP C 0.22UF	K
C35,36			CK73GB1H103K	CHIP C 0.010UF	K
C37		*	C93-1217-05	CHIP C 0.047UF	100WV
C38			CK73FB1A225K	CHIP C 2.2UF	K
C39			CK73FB0J106K	CHIP C 10UF	K
C40			CK73GB1C104K	CHIP C 0.10UF	K
C41,42			CK73FB0J106K	CHIP C 10UF	K
C43			CC73GCH1H101J	CHIP C 100PF	J
C44			CK73GB1C104K	CHIP C 0.10UF	K
J1			E59-0839-05	RECTANGULAR PLUG	
289	2C	*	J19-7054-03	HOLDER	
X1		*	L78-1208-05	RESONATOR (6.6MHZ)	
CP1,2			RK74HB1J223J	CHIP-COM 22K J 1/16W	E1E3K2
CP1,2			RK74HB1J223J	CHIP-COM 22K J 1/16W	KK1M1
CP2			RK74HB1J223J	CHIP-COM 22K J 1/16W	E2E4

E1 : KDC-W8531 E2 : KDC-W7531Y E3 : KDC-W8531Y E4 : KDC-W7531

K : KDC-X889 K1 : KDC-X789 K2 : KDC-MP828 M1 : KDC-X8529

42 (E : Europe K : North America M : Other Areas W : Without Europe)

△ Indicates safety critical components.

PARTS LIST

SWITCH UNIT (X16-2950-1x / X16-3122-71)

Ref. No.	Add	New	Parts No.	Description	Destination	Ref. No.	Add	New	Parts No.	Description	Destination
CP3		*	RK74GA1J223J	CHIP-COM 22K J 1/16W		R27,28			RK73GB2A103J	CHIP R 10K J 1/10W	
CP4			RK74HB1J472J	CHIP-COM 4.7K J 1/16W		R29			RK73GB2A102J	CHIP R 1.0K J 1/10W	
CP5			RK74GA1J332J	CHIP-COM 3.3K J 1/16W		R30			RK73GB2A223J	CHIP R 22K J 1/10W	E2E4
CP6			RK74GA1J473J	CHIP-COM 47K J 1/16W		R31			RK73GB2A223J	CHIP R 22K J 1/10W	E1E3K2
CP7			RK74HB1J473J	CHIP-COM 47K J 1/16W		R31			RK73GB2A223J	CHIP R 22K J 1/10W	KK1M1
CP8		*	RK74GA1J331J	CHIP-COM 330 J 1/16W		R33			RK73GB2A102J	CHIP R 1.0K J 1/10W	
CP9-14			RK74HB1J331J	CHIP-COM 330 J 1/16W		R34			RK73GB2A101J	CHIP R 100 J 1/10W	
CP15			RK74HB1J223J	CHIP-COM 22K J 1/16W		R36			RK73GB2A101J	CHIP R 100 J 1/10W	
CP16			RK74HB1J331J	CHIP-COM 330 J 1/16W		R37			RK73GB2A473J	CHIP R 47K J 1/10W	
CP17			RK74HB1J223J	CHIP-COM 22K J 1/16W		R38			RK73GB2A102J	CHIP R 1.0K J 1/10W	
CP18			RK74HB1J331J	CHIP-COM 330 J 1/16W		R39-41			RK73GB2A473J	CHIP R 47K J 1/10W	
CP19			RK74HB1J223J	CHIP-COM 22K J 1/16W		R42			RK73GB2A472J	CHIP R 4.7K J 1/10W	
CP20			RK74GA1J101J	CHIP-COM 100 J 1/16W		R43,44	*		RK73PB2H120J	CHIP R 12 J 1/2W	
CP21			RK74HB1J331J	CHIP-COM 330 J 1/16W		R45-49			RK73EB2E101J	CHIP R 100 J 1/4W	
CP22			RK74HB1J223J	CHIP-COM 22K J 1/16W		R50			RK73EB2E102J	CHIP R 1.0K J 1/4W	
CP23			RK74HB1J101J	CHIP-COM 100 J 1/16W		R52			RK73GB2A223J	CHIP R 22K J 1/10W	
CP24			RK74HB1J102J	CHIP-COM 1.0K J 1/16W		R53			RK73GB2A222J	CHIP R 2.2K J 1/10W	
CP25		*	RK74HB1J332J	CHIP-COM 3.3K J 1/16W		R54			RK73EB2E333J	CHIP R 33K J 1/4W	
CP26			RK74HB1J223J	CHIP-COM 22K J 1/16W		R55			RK73GB2A473J	CHIP R 47K J 1/10W	
CP27			RK74HB1J101J	CHIP-COM 100 J 1/16W		R56			RK73GB2A222J	CHIP R 2.2K J 1/10W	
CP28			RK74GA1J101J	CHIP-COM 100 J 1/16W		R58			RK73GB2A222J	CHIP R 2.2K J 1/10W	
CP29			RK74HB1J101J	CHIP-COM 100 J 1/16W		R59			RK73GB2A473J	CHIP R 47K J 1/10W	
CP30			RK74HB1J102J	CHIP-COM 1.0K J 1/16W		R60			RK73FB2B220J	CHIP R 22 J 1/8W	
CP31			RK74HB1J223J	CHIP-COM 22K J 1/16W		R61			RK73GB2A104J	CHIP R 100K J 1/10W	
CP34			RK74HB1J473J	CHIP-COM 47K J 1/16W		R62	*		RK73PB2H2R7J	CHIP R 2.7 J 1/2W	
CP35		*	RK74GA1J223J	CHIP-COM 22K J 1/16W		R64			RK73GB2A223J	CHIP R 22K J 1/10W	
R1			RK73EB2E751J	CHIP R 750 J 1/4W		R66			RK73EB2E821J	CHIP R 820 J 1/4W	
R2-4			RK73FB2B361J	CHIP R 360 J 1/8W		W1,2			R92-2053-05	CHIP R 0 OHM J 1/8W	
R5-7			RK73EB2E471J	CHIP R 470 J 1/4W		S2			S70-0901-05	TACT SWITCH	
R8			RK73FB2B271J	CHIP R 270 J 1/8W		S17,18			S70-0901-05	TACT SWITCH	
R9			RK73GB2A333J	CHIP R 33K J 1/10W		S19	*		S70-0926-15	TACT SWITCH	
R10			RK73GB2A512J	CHIP R 5.1K J 1/10W	E2E3K2	S1	*		T99-0456-05	ROTARY ENCODER	
R10			RK73GB2A512J	CHIP R 5.1K J 1/10W	E4	ED1	2C	*	JN12823A	FLUORESCENT INDICATOR TUBE	
R10			RK73GB2A512J	CHIP R 5.1K J 1/10W	KM1E1	IC1		*	MB29DL322B4T8	ROM IC	E1E3K2
R11			RK73GB2A223J	CHIP R 22K J 1/10W	K1	IC1		*	MB29DL322B4T8	ROM IC	KK1M1
R11,12			RK73GB2A223J	CHIP R 22K J 1/10W	E2E3K2	IC1		*	MX231613T14T9	ROM IC	E2E4
R11,12			RK73GB2A223J	CHIP R 22K J 1/10W	E4	IC2		*	BA3830F	ANALOGUE IC	E2E3K2
R13			RK73GB2A222J	CHIP R 2.2K J 1/10W	KM1E1	IC2			BA3830F	ANALOGUE IC	E4
R14			RK73GB2A103J	CHIP R 10K J 1/10W	E2E3K2	IC2			BA3830F	ANALOGUE IC	KM1E1
R14			RK73GB2A103J	CHIP R 10K J 1/10W	E4	IC4	*		703134GJ011-A	MICROCONTROLLER IC	
R14			RK73GB2A103J	CHIP R 10K J 1/10W	KM1E1	IC5	*		BD5237FVE	ANALOGUE IC	
R15,16			RK73GB2A274J	CHIP R 270K J 1/10W	E2E3K2	IC6			PNA4S22M	ANALOGUE IC	
R15,16			RK73GB2A274J	CHIP R 270K J 1/10W	E4	IC7			TC74LVX08FT	MOS-IC	
R15,16			RK73GB2A274J	CHIP R 270K J 1/10W	KM1E1	IC8	*		TC7WT126FU-F	MOS-IC	
R17			RK73GB2A472J	CHIP R 4.7K J 1/10W		IC9			TC7SH32FU-F	MOS-IC	
R18			RK73GB2A473J	CHIP R 47K J 1/10W		IC10	*		SI-3025KMNF	ANALOGUE IC	
R19			RK73GB2A100J	CHIP R 10 J 1/10W	E2E3K2	IC11	*		SI-3033LUSNF	ANALOGUE IC	
R19			RK73GB2A100J	CHIP R 10 J 1/10W	E4	Q1,2			2SC4617	TRANSISTOR	
R19			RK73GB2A100J	CHIP R 10 J 1/10W	KM1E1	Q3-5			2SD2351(W)	TRANSISTOR	
R20			RK73GB2A332J	CHIP R 3.3K J 1/10W		Q6			2SB1689	TRANSISTOR	
R23,24			RK73GB2A472J	CHIP R 4.7K J 1/10W		Q7			2SA1774	TRANSISTOR	
R25			RK73GB2A101J	CHIP R 100 J 1/10W	E1E3K2	Q8	*		DTC143ZE	DIGITAL TRANSISTOR	
R25			RK73GB2A101J	CHIP R 100 J 1/10W	KK1M1	Q9			2SC4617	TRANSISTOR	
R26			RK73GB2A223J	CHIP R 22K J 1/10W	E2E4						

E1 : KDC-W8531 E2 : KDC-W7531Y E3 : KDC-W8531Y E4 : KDC-W7531
K : KDC-X889 K1 : KDC-X789 K2 : KDC-MP828 M1 : KDC-X8529
(E : Europe K : North America M : Other Areas W : Without Europe)

△ Indicates safety critical components.

PARTS LIST

SWITCH UNIT (X16-2950-1x / X16-3122-71)

Ref. No.	A d d	N e w	Parts No.	Description	Desti- nation
Q10			2SA1774	TRANSISTOR	
Q11			2SC2713-F	TRANSISTOR	
Q12			2SC4667-F	TRANSISTOR	
Q13			2SB1198K	TRANSISTOR	
CD PLAYER UNIT (X32-5730-00)					
C3			CK73GB0J105K	CHIP C 1.0UF K	
C5			CK73GB1C104K	CHIP C 0.10UF K	
C7			CK73GB0J225K	CHIP C 2.2UF K	
C8			CK73GB0J105K	CHIP C 1.0UF K	
C12-14			CK73GB1C104K	CHIP C 0.10UF K	
C17,18			CK73GB1C104K	CHIP C 0.10UF K	
C21			CK73GB1H102K	CHIP C 1000PF K	
C25,26			CK73GB1C104K	CHIP C 0.10UF K	
C27			CK73GB0J105K	CHIP C 1.0UF K	
C28			CK73FB0J106M	CHIP C 10UF M	
C29			CK73GB1C104K	CHIP C 0.10UF K	
C30			CK73GB1H152K	CHIP C 1500PF K	
C31			CC73GCH1H470J	CHIP C 47PF J	
C32			CK73GB1C104K	CHIP C 0.10UF K	
C33			CK73GB0J225K	CHIP C 2.2UF K	
C34			CC73GCH1H560J	CHIP C 56PF J	
C35,36			CK73GB1C104K	CHIP C 0.10UF K	
C37			CK73GB1H102K	CHIP C 1000PF K	
C38			CK73GB1H682K	CHIP C 6800PF K	
C39			CK73GB1C104K	CHIP C 0.10UF K	
C40			CK73GB0J105K	CHIP C 1.0UF K	
C41			CK73GB0J475K	CHIP C 4.7UF K	
C44			CK73GB0J105K	CHIP C 1.0UF K	
C46			CK73GB1H682K	CHIP C 6800PF K	
C47			CK73GB1C104K	CHIP C 0.10UF K	
C48			CC73GCH1H040C	CHIP C 4.0PF C	
C49			CK73GB1H332K	CHIP C 3300PF K	
C50			CK73GB1C104K	CHIP C 0.10UF K	
C51			CC73GCH1H330J	CHIP C 33PF J	
C52			CK73FB1A225K	CHIP C 2.2UF K	
C53			CK73GB0J225K	CHIP C 2.2UF K	
C54,55			CK73GB1H103K	CHIP C 0.010UF K	
C56,57			CC73GCH1H391J	CHIP C 390PF J	
C58			CK73GB1H472K	CHIP C 4700PF K	
C59,60			CK73GB1H152K	CHIP C 1500PF K	
C61,62			CK73GB1H102K	CHIP C 1000PF K	
C63			CK73GB1H152K	CHIP C 1500PF K	
C64,65			CK73GB1C104K	CHIP C 0.10UF K	
C66,67			CC73GCH1H100D	CHIP C 10PF D	
C68			CK73FB0J106M	CHIP C 10UF M	
C72			CK73GB0J225K	CHIP C 2.2UF K	
C73			CK73GB1C104K	CHIP C 0.10UF K	
C74			CK73GB0J475K	CHIP C 4.7UF K	
C75			CC73GCH1H221J	CHIP C 220PF J	
C76,77			CK73GB1C104K	CHIP C 0.10UF K	
C78-80			CC73GCH1H221J	CHIP C 220PF J	
C81-84			CK73GB1H102K	CHIP C 1000PF K	
C85			CK73GB1C104K	CHIP C 0.10UF K	
C86			CK73GB1A105K	CHIP C 1.0UF K	
C87			CK73GB0J475K	CHIP C 4.7UF K	

Ref. No.	A d d	N e w	Parts No.	Description	Desti- nation
C88			CK73GB1H103K	CHIP C 0.010UF K	
C89			CK73GB0J105K	CHIP C 1.0UF K	
C90,91			CK73GB1H102K	CHIP C 1000PF K	
C92			CK73GB0J475K	CHIP C 4.7UF K	
C93-98			CK73GB1C104K	CHIP C 0.10UF K	
C99			CC73GCH1H060D	CHIP C 6.0PF D	
C100			CC73GCH1H020C	CHIP C 2.0PF C	
C102			CK73GB0J225K	CHIP C 2.2UF K	
CN1			E41-2083-05	FLAT CABLE CONNECTOR	
CN2			E41-2297-05	FLAT CABLE CONNECTOR	
X1			L77-2863-05	CRYSTAL RESONATOR (16.899MHZ)	
X2		*	L78-1209-05	RESONATOR (26.88MHZ)	
CP1		*	RK74GA1J223J	CHIP-COM 22K J 1/16W	
CP2,3			RK74GA1J101J	CHIP-COM 100 J 1/16W	
CP4			RK74GA1J103J	CHIP-COM 10K J 1/16W	
CP5			RK74GA1J102J	CHIP-COM 1.0K J 1/16W	
CP7			RK74GB1J102J	CHIP-COM 1.0K J 1/16W	
CP10			RK74GB1J103J	CHIP-COM 10K J 1/16W	
CP11			RK74GB1J472J	CHIP-COM 4.7K J 1/16W	
CP14			RK74GA1J104J	CHIP-COM 100K J 1/16W	
CP16			RK74GB1J104J	CHIP-COM 100K J 1/16W	
CP17			RK74GA1J102J	CHIP-COM 1.0K J 1/16W	
CP18,19			RK74GA1J104J	CHIP-COM 100K J 1/16W	
R1			RK73GB2A225J	CHIP R 2.2M J 1/10W	
R3			RK73GB2A223J	CHIP R 22K J 1/10W	
R4			RK73GB2A102J	CHIP R 1.0K J 1/10W	
R5			RK73GB2A101J	CHIP R 100 J 1/10W	
R6			RK73GH2A223D	CHIP R 22K D 1/10W	
R8			RK73GH2A393D	CHIP R 39K D 1/10W	
R9			RK73GB2A223J	CHIP R 22K J 1/10W	
R10			RK73GB2A101J	CHIP R 100 J 1/10W	
R11,12			RK73GB2A223J	CHIP R 22K J 1/10W	
R13			RK73GB2A102J	CHIP R 1.0K J 1/10W	
R14,15			RK73GB2A223J	CHIP R 22K J 1/10W	
R17			RK73GB2A221J	CHIP R 220 J 1/10W	
R18			RK73GB2A102J	CHIP R 1.0K J 1/10W	
R19			RK73GB2A472J	CHIP R 4.7K J 1/10W	
R20			RK73GB2A102J	CHIP R 1.0K J 1/10W	
R21,22			RK73GB2A103J	CHIP R 10K J 1/10W	
R23,24			RK73GB2A223J	CHIP R 22K J 1/10W	
R25			RK73GB2A102J	CHIP R 1.0K J 1/10W	
R29			RK73GB2A102J	CHIP R 1.0K J 1/10W	
R34			RK73GB2A472J	CHIP R 4.7K J 1/10W	
R35			RK73GB2A104J	CHIP R 100K J 1/10W	
R36			RK73FB2B4R7J	CHIP R 4.7 J 1/8W	
R37			RK73GB2A103J	CHIP R 10K J 1/10W	
R40			RK73GB2A274J	CHIP R 270K J 1/10W	
R41			RK73GB2A103J	CHIP R 10K J 1/10W	
R42			RK73GB2A101J	CHIP R 100 J 1/10W	
R43			RK73GB2A393J	CHIP R 39K J 1/10W	
R44,45			RK73GB2A302J	CHIP R 3.0K J 1/10W	
R48			RK73GB2A472J	CHIP R 4.7K J 1/10W	
R50			RK73GB2A101J	CHIP R 100 J 1/10W	

PARTS LIST

CD PLAYER UNIT (X32-5730-00)

Ref. No.	Add	New	Parts No.	Description	Destination
R51			RK73GB2A392J	CHIP R 3.9K J 1/10W	
R52			RK73GB2A163J	CHIP R 16K J 1/10W	
R53			RK73GB2A123J	CHIP R 12K J 1/10W	
R54			RK73GB2A333J	CHIP R 33K J 1/10W	
R55			RK73GB2A103J	CHIP R 10K J 1/10W	
R56			RK73GB2A123J	CHIP R 12K J 1/10W	
R57,58			RK73GB2A133J	CHIP R 13K J 1/10W	
R59			RK73GB2A472J	CHIP R 4.7K J 1/10W	
R60			RK73GB2A123J	CHIP R 12K J 1/10W	
R61			RK73GB2A183J	CHIP R 18K J 1/10W	
R62			RK73GB2A432J	CHIP R 4.3K J 1/10W	
R63			RK73GB2A133J	CHIP R 13K J 1/10W	
R64			RK73GB2A151J	CHIP R 150 J 1/10W	
R65			RK73GB2A152J	CHIP R 1.5K J 1/10W	
R67,68			RK73GB2A152J	CHIP R 1.5K J 1/10W	
R69			RK73GB2A682J	CHIP R 6.8K J 1/10W	
R70			RK73GB2A102J	CHIP R 1.0K J 1/10W	
R71-73			RK73GB2A101J	CHIP R 100 J 1/10W	
R108-110			RK73GH2A392D	CHIP R 3.9K D 1/10W	
R111,112			RK73GH2A562D	CHIP R 5.6K D 1/10W	
R113			RK73GH2A392D	CHIP R 3.9K D 1/10W	
R114			RK73GH2A562D	CHIP R 5.6K D 1/10W	
R115			RK73GH2A392D	CHIP R 3.9K D 1/10W	
R116			RK73GH2A562D	CHIP R 5.6K D 1/10W	
R117			RK73GH2A392D	CHIP R 3.9K D 1/10W	
R118,119			RK73GH2A100D	CHIP R 10 D 1/10W	
R120,121			RK73GH2A392D	CHIP R 3.9K D 1/10W	
R122			RK73GH2A202D	CHIP R 2.0K D 1/10W	
R123			RK73GH2A102D	CHIP R 1.0K D 1/10W	
R124			RK73GB2A680J	CHIP R 68 J 1/10W	
R128,129			RK73GB2A101J	CHIP R 100 J 1/10W	
R130			RK73GB2A221J	CHIP R 220 J 1/10W	
R132			RK73GB2A102J	CHIP R 1.0K J 1/10W	
R133			RK73GB2A561J	CHIP R 560 J 1/10W	
R134			RK73GH2A202D	CHIP R 2.0K D 1/10W	
R135			RK73GH2A102D	CHIP R 1.0K D 1/10W	
R137			RK73GB2A680J	CHIP R 68 J 1/10W	
R138			RK73GB2A471J	CHIP R 470 J 1/10W	
R139-141			RK73GH2A111D	CHIP R 110 D 1/10W	
R142			RK73GB2A6R8J	CHIP R 6.8 J 1/10W	
R144			RK73GB2A222J	CHIP R 2.2K J 1/10W	
R145			RK73GB2A102J	CHIP R 1.0K J 1/10W	
R146			RK73GB2A332J	CHIP R 3.3K J 1/10W	
R147,148			RK73GB2A103J	CHIP R 10K J 1/10W	
R150			RK73GB2A103J	CHIP R 10K J 1/10W	
R151			RK73GB2A102J	CHIP R 1.0K J 1/10W	
R152			RK73GB2A221J	CHIP R 220 J 1/10W	
R153-155			RK73GB2A330J	CHIP R 33 J 1/10W	
S1,2			S68-0863-05	PUSH SWITCH	
S3			S68-0862-05	PUSH SWITCH	
D2			DA204U	DIODE	
D3			DAN202U	DIODE	
D4,5			MAZS0510L	ZENER DIODE	
D6			DAN202U	DIODE	

Ref. No.	Add	New	Parts No.	Description	Destination
IC1			91CU27UG5UR8	MICROCONTROLLER IC	
IC2			UPD63712GC	MOS-IC	
IC4			BA5824FP	ANALOGUE IC	
IC5			NJM2886DL2-33	ANALOGUE IC	
IC13			NJM4580V-ZB	ANALOGUE IC	
IC14			TAR5S50-F	ANALOGUE IC	
IC15		*	CS7410-IQZ	MOS-IC	
IC16		*	MSM56V16160F10	DRAM IC	
IC17		*	W400DB55N6E6T8	ROM IC	
IC18			PCM1793DB	MOS-IC	
IC19			S-1112B33MCG	ANALOGUE IC	
IC20		*	XC6219B182PR	ANALOGUE IC	
IC21		*	XC6219B332PR	ANALOGUE IC	
Q1			2SK3018	FET	
Q3			UMD9N	TRANSISTOR	
Q4			2SK3018	FET	
Q5			UMD9N	TRANSISTOR	
Q6			UMD12N	TRANSISTOR	
Q7			DTC124EUA	DIGITAL TRANSISTOR	
Q8		*	2SB0970(R)	TRANSISTOR	
Q9,10			DTC114YUA	DIGITAL TRANSISTOR	
Q11			2SK210(GR)	FET	
Q12			DTA143XUA	DIGITAL TRANSISTOR	
Q13			DTC143XUA	DIGITAL TRANSISTOR	
Q14			DTC114YUA	DIGITAL TRANSISTOR	
Q15		*	2SB0970(R)	TRANSISTOR	
ELECTRIC UNIT (X34-3xxx-xx)					
D451			B30-1566-05	LED (RED)	
C1		*	C90-6743-05	ELECTRO 3900UF 16WV	KK1M1
C1			C90-6744-05	ELECTRO 3900UF 16WV	E1E2E3
C1			C90-6744-05	ELECTRO 3900UF 16WV	K2E4
C10			CK73FB1C105K	CHIP C 1.0UF K	
C11			CD04AY1A221M	ELECTRO 220UF 10WV	
C20			CD04BA0J101M	ELECTRO 100UF 6.3WV	
C21			C90-5692-05	ELECTRO 220UF 16WV	
C22			CK73GB1H103K	CHIP C 0.010UF K	
C23			CE32CL1C100M	CHIP EL 10UF 16WV	
C30			CK73GB1A474K	CHIP C 0.47UF K	
C31			CD04AY1A101M	ELECTRO 100UF 10WV	
C32			CK73GB1A474K	CHIP C 0.47UF K	
C33		*	CE32BJ1C101M	CHIP EL 100UF 16WV	
C40			CK73GB1H103K	CHIP C 0.010UF K	
C41			CD04BA0J470M	ELECTRO 47UF 6.3WV	
C42			CK73GB1C104K	CHIP C 0.10UF K	
C43			CK73GB1H104K	CHIP C 0.10UF K	
C44			CD04AS1C100M	ELECTRO 10UF 16WV	
C50			CK73GB1H104K	CHIP C 0.10UF K	
C51			CD04AS1C470M	ELECTRO 47UF 16WV	
C60			CK73FB1C474K	CHIP C 0.47UF K	
C61			CK73GB0J105K	CHIP C 1.0UF K	
C63			CK73FB0J106K	CHIP C 10UF K	
C64			CK73GB1H103K	CHIP C 0.010UF K	
C67			CK73GB1H103K	CHIP C 0.010UF K	

E1 : KDC-W8531 E2 : KDC-W7531Y E3 : KDC-W8531Y E4 : KDC-W7531
K : KDC-X889 K1 : KDC-X789 K2 : KDC-MP828 M1 : KDC-X8529
(E : Europe K : North America M : Other Areas W : Without Europe)

△ Indicates safety critical components.

PARTS LIST

ELECTRIC UNIT (X34-3xxx-xx)

Ref. No.	A	N	Parts No.	Description	Desti-	Ref. No.	A	N	Parts No.	Description	Desti-
	d	e			nation		d	e			nation
C68			CK73GB1C104K	CHIP C 0.10UF K		C369			CK73FB1A105K	CHIP C 1.0UF K	
C69			CK73FB0J106K	CHIP C 10UF K		C370			CK73GB1C104K	CHIP C 0.10UF K	KK2
C71			CK73GB1C104K	CHIP C 0.10UF K		C371			CK73GB0J105K	CHIP C 1.0UF K	KK2
C72			CK73GB1C683K	CHIP C 0.068UF K		C374			CK73GB1C104K	CHIP C 0.10UF K	KK2
C73		*	CK73EB1C106K	CHIP C 10UF K		C376			CK73GB1C104K	CHIP C 0.10UF K	KK2
C74		*	CD04BK1E101M	ELECTRO 100UF 25WV		C377			CK73GB0J105K	CHIP C 1.0UF K	KK2
C75			CD04BF1C101M	ELECTRO 100UF 16WV		C378			CK73GB1E473K	CHIP C 0.047UF K	KK2
C76			CK73GB1C224K	CHIP C 0.22UF K		C379			CK73GB1C104K	CHIP C 0.10UF K	KK2
C81		*	C93-1382-05	CHIP C 1UF K		C380			CK73GB0J105K	CHIP C 1.0UF K	KK2
C82		*	C93-1381-05	CHIP C 1UF K		C381			CK73GB1E473K	CHIP C 0.047UF K	KK2
C84		*	C93-1381-05	CHIP C 1UF K		C382			CK73GB1C104K	CHIP C 0.10UF K	KK2
C85		*	C93-1382-05	CHIP C 1UF K		C383			CK73GB0J105K	CHIP C 1.0UF K	KK2
C86			CK73EB1C105K	CHIP C 1.0UF K		C384			CK73FB1A105K	CHIP C 1.0UF K	
C87			CK73GB1H103K	CHIP C 0.010UF K		C385,386			CK73GB1H152K	CHIP C 1500PF K	
C88			CK73GB1C224K	CHIP C 0.22UF K		C387-392			CC73GCH1H101J	CHIP C 100PF J	KK2
C100			CK73GB1H104K	CHIP C 0.10UF K		C387,388			CC73GCH1H101J	CHIP C 100PF J	E2E3E4
C102,103			CC73GCH1H220J	CHIP C 22PF J		C387,388			CC73GCH1H101J	CHIP C 100PF J	K1M1E1
C104-106			CK73GB1H103K	CHIP C 0.010UF K		C393-395			CE32CL1C100M	CHIP EL 10UF 16WV	KK2
C107			CK73GB1H102K	CHIP C 1000PF K		C396,397			CC73GCH1H101J	CHIP C 100PF J	KK2
C109-113			CK73GB1H103K	CHIP C 0.010UF K		C398,399			CK73GB1C104K	CHIP C 0.10UF K	KK2
C114			CD04AS0J470M	ELECTRO 47UF 6.3WV		C402			CK73GB1H103K	CHIP C 0.010UF K	E2E3K2
C200,201			CK73GB1H103K	CHIP C 0.010UF K		C402			CK73GB1H103K	CHIP C 0.010UF K	E4
C202			CK73GB1H102K	CHIP C 1000PF K		C402			CK73GB1H103K	CHIP C 0.010UF K	KK1E1
C203			CK73GB1E223K	CHIP C 0.022UF K		C403			CK73FB1A225K	CHIP C 2.2UF K	E2E3K2
C204			CK73GB1H103K	CHIP C 0.010UF K		C403			CK73FB1A225K	CHIP C 2.2UF K	E4
C205,206			CK73FB1C105K	CHIP C 1.0UF K		C403			CK73FB1A225K	CHIP C 2.2UF K	KK1E1
C298,299			CK73GB1C104K	CHIP C 0.10UF K	KK2	C404			CC73GCH1H331J	CHIP C 330PF J	E2E3K2
C300			CD04AS1C470M	ELECTRO 47UF 16WV		C404			CC73GCH1H331J	CHIP C 330PF J	E4
C301			CD04AT1H010M	ELECTRO 1UF 50WV		C404			CC73GCH1H331J	CHIP C 330PF J	KK1E1
C302			CD04AS1E4R7M	ELECTRO 4.7UF 25WV		C405			CD04AT1C100M	ELECTRO 10UF 16WV	E2E3K2
C303,304			CD04AS1H3R3M	ELECTRO 3.3UF 50WV		C405			CD04AT1C100M	ELECTRO 10UF 16WV	E4
C305			CK73FB1A105K	CHIP C 1.0UF K		C405			CD04AT1C100M	ELECTRO 10UF 16WV	KK1E1
C306			CK73GB1H103K	CHIP C 0.010UF K		C407			CK73GB1H103K	CHIP C 0.010UF K	
C307			CE32CL1C100M	CHIP EL 10UF 16WV		C409,410			CK73GB1H103K	CHIP C 0.010UF K	
C308,309			CD04AS1H2R2M	ELECTRO 2.2UF 50WV		C412			CK73GB1H103K	CHIP C 0.010UF K	
C310,311			CK73FB1C474K	CHIP C 0.47UF K		C414,415			CC73GCH1H120J	CHIP C 12PF J	E2E3K2
C312			CK73GB1H152K	CHIP C 1500PF K	KK2	C414,415			CC73GCH1H120J	CHIP C 12PF J	E4
C314			CD04AS1C220M	ELECTRO 22UF 16WV	KK2	C414,415			CC73GCH1H120J	CHIP C 12PF J	KK1E1
C315			CK73GB1H152K	CHIP C 1500PF K	KK2	C450-452			CK73GB1C104K	CHIP C 0.10UF K	E1E2E3
C317			CD04AS1C220M	ELECTRO 22UF 16WV	KK2	C450-452			CK73GB1C104K	CHIP C 0.10UF K	E4
C318,319			CK73GB1C104K	CHIP C 0.10UF K	KK2	C450-455			CK73GB1C104K	CHIP C 0.10UF K	KK1M1
C320			CE32CL1C100M	CHIP EL 10UF 16WV	KK2	C450-455			CK73GB1C104K	CHIP C 0.10UF K	K2
C321-323			CK73GB1C104K	CHIP C 0.10UF K	KK2	C458			CK73GB0J105K	CHIP C 1.0UF K	KK1M1
C324,325			CC73GCH1H060D	CHIP C 6.0PF D	KK2	C458			CK73GB0J105K	CHIP C 1.0UF K	K2
C326			CK73GB1H103K	CHIP C 0.010UF K	KK2	C500-504			CK73EB1A475K	CHIP C 4.7UF K	E2E3K2
C327-334			CD04AS1C100M	ELECTRO 10UF 16WV	KK2	C500-504			CK73EB1A475K	CHIP C 4.7UF K	E4
C335-340			CK73GB1H102K	CHIP C 1000PF K	KK2	C500-504			CK73EB1A475K	CHIP C 4.7UF K	KM1E1
C341-346			CC73GCH1H821J	CHIP C 820PF J	KK2	C505			CK73GB1H103K	CHIP C 0.010UF K	E2E3K2
C347-350			CC73GCH1H221J	CHIP C 220PF J	KK2	C505			CK73GB1H103K	CHIP C 0.010UF K	E4
C351-354			CC73GCH1H181J	CHIP C 180PF J	KK2	C505			CK73GB1H103K	CHIP C 0.010UF K	KM1E1
C355-360			CD04AT1C100M	ELECTRO 10UF 16WV	KK2	C506			CE32CL1C100M	CHIP EL 10UF 16WV	E2E3K2
C364,365			CD04AS1H010M	ELECTRO 1UF 50WV		C506			CE32CL1C100M	CHIP EL 10UF 16WV	E4
C366			CK73GB1C104K	CHIP C 0.10UF K	KK2	C506			CE32CL1C100M	CHIP EL 10UF 16WV	KM1E1
C367			CE32CL1C100M	CHIP EL 10UF 16WV	KK2	C550,551			CK73GB1H103K	CHIP C 0.010UF K	
C368			CK73GB1H682K	CHIP C 6800PF K	KK2	C600,601			CK73EB1C225K	CHIP C 2.2UF K	E1E3K2

E1 : KDC-W8531 E2 : KDC-W7531Y E3 : KDC-W8531Y E4 : KDC-W7531

K : KDC-X889 K1 : KDC-X789 K2 : KDC-MP828 M1 : KDC-X8529

46 (E : Europe K : North America M : Other Areas W : Without Europe)

△ Indicates safety critical components.

PARTS LIST

ELECTRIC UNIT (X34-3xxx-xx)

Ref. No.	Add	New	Parts No.	Description	Destination	Ref. No.	Add	New	Parts No.	Description	Destination
C600,601			CK73EB1C225K	CHIP C 2.2UF K	KK1M1	CN600			E41-0224-05	PIN ASSY	
C602			CK73GB1H103K	CHIP C 0.010UF K	E1E3K2	J1			E58-0991-05	RECTANGULAR RECEPTACLE	
C602			CK73GB1H103K	CHIP C 0.010UF K	KK1M1	J2			E56-0855-05	CYLINDRICAL RECEPTACLE	
C603			CK73GB1E223K	CHIP C 0.022UF K	E1E3K2	P1			E23-0745-05	TERMINAL	
C603			CK73GB1E223K	CHIP C 0.022UF K	KK1M1	W400	1D	*	E30-6438-05	CORD WITH PLUG	
C604			CD04AS1C220M	ELECTRO 22UF 16WV	E1E3K2	L1			L33-1988-05	CHOKE COIL ASSY	
C604			CD04AS1C220M	ELECTRO 22UF 16WV	KK1M1	L60		*	L33-2229-05	SMALL FIXED INDUCTOR (68UH)	
C605-608			CK73EB1C225K	CHIP C 2.2UF K	E1E3K2	L61		*	L33-2230-05	SMALL FIXED INDUCTOR (100UH)	
C605-608			CK73EB1C225K	CHIP C 2.2UF K	KK1M1	L81		*	L33-2228-05	SMALL FIXED INDUCTOR (4.7UH)	
C609			CD04BF1C101M	ELECTRO 100UF 16WV	E1E3K2	L100			L92-0075-05	CHIP FERRITE	
C609			CD04BF1C101M	ELECTRO 100UF 16WV	KK1M1	L101			L41-4795-33	SMALL FIXED INDUCTOR (4.7UH)	
C610			CD04AS1C220M	ELECTRO 22UF 16WV	E1E3K2	L400			L33-2260-05	CHOKE COIL	
C610			CD04AS1C220M	ELECTRO 22UF 16WV	KK1M1	L401			L41-4795-33	SMALL FIXED INDUCTOR (4.7UH)	
C610			CD04AS1E4R7M	ELECTRO 4.7UF 25WV	E2E4	L403			L41-4795-33	SMALL FIXED INDUCTOR (4.7UH)	
C611			CE32CL1C100M	CHIP EL 10UF 16WV		L405			L41-4795-33	SMALL FIXED INDUCTOR (4.7UH)	E2E3K2
C612,613			CD04AT1C100M	ELECTRO 10UF 16WV	E1E3K2	L405			L41-4795-33	SMALL FIXED INDUCTOR (4.7UH)	E4
C612,613			CD04AT1C100M	ELECTRO 10UF 16WV	KK1M1	L405			L41-4795-33	SMALL FIXED INDUCTOR (4.7UH)	KK1E1
C614,615			CE32CL1C100M	CHIP EL 10UF 16WV		L600			L41-2205-33	SMALL FIXED INDUCTOR (22UH)	E1E3K2
C616,617			CD04AT1C100M	ELECTRO 10UF 16WV		L600			L41-2205-33	SMALL FIXED INDUCTOR (22UH)	KK1M1
C618,619			CE32CL1C100M	CHIP EL 10UF 16WV		X100			L78-0872-05	RESONATOR (12MHZ)	
C620,621			CD04AS1C100M	ELECTRO 10UF 16WV		X101			L77-2880-05	CRYSTAL RESONATOR (32.768KHZ)	
C622			CE32CL1C100M	CHIP EL 10UF 16WV		X300			L77-2857-05	CRYSTAL RESONATOR (11.2896MH)	KK2
C623-628			CK73GB1H102K	CHIP C 1000PF K	E1E3K2	X401			L77-2002-05	CRYSTAL RESONATOR (4.332MHZ)	E2E3K2
C623-628			CK73GB1H102K	CHIP C 1000PF K	KK1M1	X401			L77-2002-05	CRYSTAL RESONATOR (4.332MHZ)	E4
C629			CK73FB1C474K	CHIP C 0.47UF K		X401			L77-2002-05	CRYSTAL RESONATOR (4.332MHZ)	KK1E1
C630			CD04AT0J470M	ELECTRO 47UF 6.3WV		Q	1D		N83-3005-48	PAN HEAD TAPTITE SCREW	
C631			CK73FB1C474K	CHIP C 0.47UF K		T	2D		N80-3010-48	PAN HEAD TAPTITE SCREW	
C632			CK73GB1H103K	CHIP C 0.010UF K		V	2D		N83-3020-48	PAN HEAD TAPTITE SCREW	
C633,634			CE32CL1C100M	CHIP EL 10UF 16WV							
C635-638			CK73GB0J105K	CHIP C 1.0UF K	E1E3K2	CP100			RK74GB1J101J	CHIP-COM 100 J 1/16W	
C635-638			CK73GB0J105K	CHIP C 1.0UF K	KK1M1	CP101-103			RK74GA1J101J	CHIP-COM 100 J 1/16W	KK1M1
C701			CK73FB1C474K	CHIP C 0.47UF K		CP101-103			RK74GA1J101J	CHIP-COM 100 J 1/16W	K2
C702			CD04AS0J470M	ELECTRO 47UF 6.3WV		CP101,102			RK74GA1J101J	CHIP-COM 100 J 1/16W	E1E2E3
C703			CK73FB1C474K	CHIP C 0.47UF K		CP101,102			RK74GA1J101J	CHIP-COM 100 J 1/16W	E4
C704			CK73GB1H103K	CHIP C 0.010UF K		CP104			RK74GA1J102J	CHIP-COM 1.0K J 1/16W	
C750			CK73FB1C105K	CHIP C 1.0UF K		CP105			RK74GB1J101J	CHIP-COM 100 J 1/16W	KK2
C752-755	*		C90-6742-05	NP-ELECT 4.7UF 16WV		CP106			RK74GA1J103J	CHIP-COM 10K J 1/16W	
C756			CD04AS1A101M	ELECTRO 100UF 10WV		CP107			RK74GB1J102J	CHIP-COM 1.0K J 1/16W	
C757	*		C90-6742-05	NP-ELECT 4.7UF 16WV		CP108			RK74GA1J222J	CHIP-COM 2.2K J 1/16W	
C758			CK73GB1H103K	CHIP C 0.010UF K		CP109			RK74GB1J101J	CHIP-COM 100 J 1/16W	E2E3K2
C759			CK73FB1C105K	CHIP C 1.0UF K		CP109			RK74GB1J101J	CHIP-COM 100 J 1/16W	E4
C800-802			CD04AS1C100M	ELECTRO 10UF 16WV		CP109			RK74GB1J101J	CHIP-COM 100 J 1/16W	KK1E1
C803			CK73GB1H104K	CHIP C 0.10UF K		CP110,111			RK74GA1J101J	CHIP-COM 100 J 1/16W	
C804			CK73GB1H103K	CHIP C 0.010UF K		CP300			RK74GB1J101J	CHIP-COM 100 J 1/16W	KK2
C805			CD04AS1C470M	ELECTRO 47UF 16WV		R1			RK73EB2E102J	CHIP R 1.0K J 1/4W	E1E2E3
C806,807			CK73GB1H102K	CHIP C 1000PF K		R1			RK73EB2E102J	CHIP R 1.0K J 1/4W	E4
C808			CD04BA1C101M	ELECTRO 100UF 16WV		R1			RK73EB2E102J	CHIP R 1.0K J 1/4W	KK1M1
C809			CC73GCH1H101J	CHIP C 100PF J		R2,3			RK73EB2E103J	CHIP R 10K J 1/4W	
C812			CC73GCH1H471J	CHIP C 470PF J		R10			RK73GH2A243D	CHIP R 24K D 1/10W	
C813			CC73GCH1H101J	CHIP C 100PF J		R11			RK73FB2B221J	CHIP R 220 J 1/8W	
CN5			E41-0944-05	PIN ASSY	E2E3E4	R12			RK73GB2A153J	CHIP R 15K J 1/10W	
CN5			E41-0944-05	PIN ASSY	KK1E1	R13			RK73GH2A432D	CHIP R 4.3K D 1/10W	
CN450	*		E41-2259-05	PIN ASSY		R20			RK73FB2B203J	CHIP R 20K J 1/8W	
CN500	*		E41-2344-05	FLAT CABLE CONNECTOR		R21			RK73GB2A223J	CHIP R 22K J 1/10W	
CN550	*		E41-2352-05	FLAT CABLE CONNECTOR		R22			RK73GB2A101J	CHIP R 100 J 1/10W	

E1 : KDC-W8531 E2 : KDC-W7531Y E3 : KDC-W8531Y E4 : KDC-W7531
K : KDC-X889 K1 : KDC-X789 K2 : KDC-MP828 M1 : KDC-X8529
(E : Europe K : North America M : Other Areas W : Without Europe)

△ Indicates safety critical components.

PARTS LIST

ELECTRIC UNIT (X34-3xxx-xx)

Ref. No.	A d	N e w	Parts No.	Description	Desti- nation	Ref. No.	A d	N e w	Parts No.	Description	Desti- nation
R23			RK73FB2B272J	CHIP R 2.7K J 1/8W		R130			RK73GB2A222J	CHIP R 2.2K J 1/10W	
R30			RK73FB2B102J	CHIP R 1.0K J 1/8W		R131			RK73GB2A473J	CHIP R 47K J 1/10W	
R31			RK73FB2B152J	CHIP R 1.5K J 1/8W		R132,133			RK73GB2A472J	CHIP R 4.7K J 1/10W	
R40			RK73FB2B223J	CHIP R 22K J 1/8W		R134			RK73GB2A101J	CHIP R 100 J 1/10W	
R41			RK73FB2B182J	CHIP R 1.8K J 1/8W		R136-138			RK73GB2A104J	CHIP R 100K J 1/10W	KK2
R42			RK73GB2A105J	CHIP R 1.0M J 1/10W		R139			RK73GB2A473J	CHIP R 47K J 1/10W	
R46			RK73SB3A2R2J	CHIP R 2.2 J 1W		R140			RK73GB2A104J	CHIP R 100K J 1/10W	KK2
R50			RK73FB2B152J	CHIP R 1.5K J 1/8W		R141,142			RK73GB2A473J	CHIP R 47K J 1/10W	
R52			RK73FB2B102J	CHIP R 1.0K J 1/8W		R144,145			RK73GB2A101J	CHIP R 100 J 1/10W	
R60			RK73GH2A103D	CHIP R 10K D 1/10W		R146			RK73GB2A333J	CHIP R 33K J 1/10W	
R61			RN73GH1J153D	CHIP R 15K D 1/16W		R147			RK73GB2A102J	CHIP R 1.0K J 1/10W	
R62			RK73GB2A103J	CHIP R 10K J 1/10W		R148			RK73GB2A473J	CHIP R 47K J 1/10W	
R63,64			RK73GH2A103D	CHIP R 10K D 1/10W		R149,150			RK73GB2A223J	CHIP R 22K J 1/10W	
R66			RK73GB2A104J	CHIP R 100K J 1/10W		R153			RK73GB2A223J	CHIP R 22K J 1/10W	K2
R67			RK73GH2A273D	CHIP R 27K D 1/10W		R153-155			RK73GB2A223J	CHIP R 22K J 1/10W	K1
R68			RN73GH1J243D	CHIP R 24K D 1/16W		R153-156			RK73GB2A223J	CHIP R 22K J 1/10W	K
R69			RK73GB2A104J	CHIP R 100K J 1/10W		R154			RK73GB2A223J	CHIP R 22K J 1/10W	E1E2E3
R70			RK73GH2A303D	CHIP R 30K D 1/10W		R154			RK73GB2A223J	CHIP R 22K J 1/10W	E4
R71		*	RN73GH1J1912D	CHIP R 19.1K D 1/16W		R154-157			RK73GB2A223J	CHIP R 22K J 1/10W	M1
R73			RK73GB2A103J	CHIP R 10K J 1/10W		R155,156			RK73GB2A223J	CHIP R 22K J 1/10W	K2
R74			RK73GH2A822D	CHIP R 8.2K D 1/10W		R156,157			RK73GB2A223J	CHIP R 22K J 1/10W	E2E4
R75			RK73GB2A105J	CHIP R 1.0M J 1/10W		R157			RK73GB2A223J	CHIP R 22K J 1/10W	E1E3
R76,77			RK73GB2A104J	CHIP R 100K J 1/10W		R158			RK73GB2A223J	CHIP R 22K J 1/10W	K2
R79			RK73GB2A102J	CHIP R 1.0K J 1/10W		R159			RK73GB2A223J	CHIP R 22K J 1/10W	E2E4
R80		*	RK73GH2A434D	CHIP R 430K D 1/10W		R159,160			RK73GB2A223J	CHIP R 22K J 1/10W	E1E3
R81			RK73GB2A473J	CHIP R 47K J 1/10W		R160			RK73GB2A223J	CHIP R 22K J 1/10W	K1
R82			RK73GH2A103D	CHIP R 10K D 1/10W		R163			RK73GB2A104J	CHIP R 100K J 1/10W	
R83			RK73GB2A104J	CHIP R 100K J 1/10W		R164			RK73GB2A223J	CHIP R 22K J 1/10W	
R84			RK73GH2A153D	CHIP R 15K D 1/10W		R165,166			RK73GB2A222J	CHIP R 2.2K J 1/10W	
R85		*	RK73PB2H102J	CHIP R 1.0K J 1/2W		R168			RK73GB2A222J	CHIP R 2.2K J 1/10W	
R86			RK73GB2A473J	CHIP R 47K J 1/10W		R170-173			RK73GB2A223J	CHIP R 22K J 1/10W	
R91,92			RK73GB2A104J	CHIP R 100K J 1/10W		R176			RK73GB2A104J	CHIP R 100K J 1/10W	
R93			RK73FB2B431J	CHIP R 430 J 1/8W		R177			RK73GB2A223J	CHIP R 22K J 1/10W	
R100-104			RK73GB2A104J	CHIP R 100K J 1/10W		R178			RK73GB2A473J	CHIP R 47K J 1/10W	
R105			RK73GB2A101J	CHIP R 100 J 1/10W		R181			RK73GB2A473J	CHIP R 47K J 1/10W	
R106			RK73GB2A222J	CHIP R 2.2K J 1/10W		R183			RK73GB2A473J	CHIP R 47K J 1/10W	
R107			RK73GB2A473J	CHIP R 47K J 1/10W		R185			RK73GB2A102J	CHIP R 1.0K J 1/10W	
R109			RK73GB2A223J	CHIP R 22K J 1/10W		R187			RK73GB2A473J	CHIP R 47K J 1/10W	
R110			RK73GB2A103J	CHIP R 10K J 1/10W		R200			RK73EB2E473J	CHIP R 47K J 1/4W	
R111			RK73GB2A104J	CHIP R 100K J 1/10W		R201			RD14DB2H332J-T	SMALL-RD 3.3K J 1/2W	
R112			RK73GB2A473J	CHIP R 47K J 1/10W		R202			RK73GB2A183J	CHIP R 18K J 1/10W	
R113			RK73GB2A103J	CHIP R 10K J 1/10W		R203			RK73GB2A104J	CHIP R 100K J 1/10W	
R114			RK73GB2A473J	CHIP R 47K J 1/10W		R204			RK73GB2A393J	CHIP R 39K J 1/10W	
R115			RK73GB2A101J	CHIP R 100 J 1/10W		R205			RK73GB2A103J	CHIP R 10K J 1/10W	
R117			RK73GB2A101J	CHIP R 100 J 1/10W		R206			RK73GB2A474J	CHIP R 470K J 1/10W	
R118			RK73GB2A102J	CHIP R 1.0K J 1/10W		R207			RK73GB2A103J	CHIP R 10K J 1/10W	
R119			RK73GB2A223J	CHIP R 22K J 1/10W		R208			RK73EB2E101J	CHIP R 100 J 1/4W	
R120			RK73GB2A104J	CHIP R 100K J 1/10W		R209			RK73FB2B683J	CHIP R 68K J 1/8W	
R121			RK73GB2A103J	CHIP R 10K J 1/10W		R210			RK73FB2B203J	CHIP R 20K J 1/8W	
R122,123			RK73GB2A101J	CHIP R 100 J 1/10W		R211			RK73GB2A103J	CHIP R 10K J 1/10W	
R125			RK73GB2A222J	CHIP R 2.2K J 1/10W		R212			RK73GB2A223J	CHIP R 22K J 1/10W	
R126			RK73GB2A101J	CHIP R 100 J 1/10W		R213			RK73GB2A473J	CHIP R 47K J 1/10W	
R127			RK73GB2A103J	CHIP R 10K J 1/10W		R214			RK73GB2A104J	CHIP R 100K J 1/10W	
R128			RK73GB2A222J	CHIP R 2.2K J 1/10W		R215			RK73FB2B561J	CHIP R 560 J 1/8W	E1E2E3
R129			RK73GB2A102J	CHIP R 1.0K J 1/10W		R215			RK73FB2B561J	CHIP R 560 J 1/8W	E4

E1 : KDC-W8531 E2 : KDC-W7531Y E3 : KDC-W8531Y E4 : KDC-W7531

K : KDC-X889 K1 : KDC-X789 K2 : KDC-MP828 M1 : KDC-X8529

48 (E : Europe K : North America M : Other Areas W : Without Europe)

△ Indicates safety critical components.

PARTS LIST

ELECTRIC UNIT (X34-3xxx-xx)

Ref. No.	Add	New	Parts No.	Description	Destination	Ref. No.	Add	New	Parts No.	Description	Destination
R215			RK73FB2B561J	CHIP R 560 J 1/8W	KK1M1	R500			RK73GB2A473J	CHIP R 47K J 1/10W	E4
R216			RK73GB2A223J	CHIP R 22K J 1/10W	KK1M1	R500			RK73GB2A473J	CHIP R 47K J 1/10W	KK1M1
R216			RK73GB2A223J	CHIP R 22K J 1/10W	K2	R501			RK73EB2E101J	CHIP R 100 J 1/4W	
R217			RK73SB3A471J	CHIP R 470 J 1W	KK1M1	R502			RK73GB2A102J	CHIP R 1.0K J 1/10W	E2E3K2
R217			RK73SB3A471J	CHIP R 470 J 1W	K2	R502			RK73GB2A102J	CHIP R 1.0K J 1/10W	E4
R218,219			RK73FB2B472J	CHIP R 4.7K J 1/8W		R502			RK73GB2A102J	CHIP R 1.0K J 1/10W	KK1M1
R300			RK73EB2E2R2J	CHIP R 2.2 J 1/4W		R503			RK73GB2A333J	CHIP R 33K J 1/10W	E2E3K2
R301			RK73GB2A103J	CHIP R 10K J 1/10W		R503			RK73GB2A333J	CHIP R 33K J 1/10W	E4
R302,303			RK73GB2A471J	CHIP R 470 J 1/10W	KK2	R503			RK73GB2A333J	CHIP R 33K J 1/10W	KK1M1
R304-307			RK73GB2A241J	CHIP R 240 J 1/10W	KK2	R504,505			RK73GB2A473J	CHIP R 47K J 1/10W	E2E3K2
R308-311			RK73GB2A103J	CHIP R 10K J 1/10W	KK2	R504,505			RK73GB2A473J	CHIP R 47K J 1/10W	E4
R312,313			RK73GB2A471J	CHIP R 470 J 1/10W	KK2	R504,505			RK73GB2A473J	CHIP R 47K J 1/10W	KK1M1
R314-317			RK73GB2A241J	CHIP R 240 J 1/10W	KK2	R506			RK73GB2A821J	CHIP R 820 J 1/10W	E2E3K2
R318-321			RK73GB2A103J	CHIP R 10K J 1/10W	KK2	R506			RK73GB2A821J	CHIP R 820 J 1/10W	E4
R322			RK73FB2B2R2J	CHIP R 2.2 J 1/8W	KK2	R506			RK73GB2A821J	CHIP R 820 J 1/10W	KK1M1
R323-330			RK73GB2A221J	CHIP R 220 J 1/10W	KK2	R507			RK73GB2A104J	CHIP R 100K J 1/10W	E2E3K2
R331			RK73GB2A473J	CHIP R 47K J 1/10W	KK2	R507			RK73GB2A104J	CHIP R 100K J 1/10W	E4
R333			RK73FB2B2R2J	CHIP R 2.2 J 1/8W	KK2	R507			RK73GB2A104J	CHIP R 100K J 1/10W	KK1M1
R334			RK73GB2A2R2J	CHIP R 2.2 J 1/10W	KK2	R508			RK73GB2A101J	CHIP R 100 J 1/10W	E2E3K2
R335,336			RK73GB2A101J	CHIP R 100 J 1/10W	KK2	R508			RK73GB2A101J	CHIP R 100 J 1/10W	E4
R337			RK73GB2A473J	CHIP R 47K J 1/10W	KK2	R508			RK73GB2A101J	CHIP R 100 J 1/10W	KK1M1
R342-357			RK73GB2A272J	CHIP R 2.7K J 1/10W	KK2	R509			RK73EB2E103J	CHIP R 10K J 1/4W	E2E3K2
R358-361			RK73GB2A332J	CHIP R 3.3K J 1/10W	KK2	R509			RK73EB2E103J	CHIP R 10K J 1/4W	E4
R362-364			RK73GB2A682J	CHIP R 6.8K J 1/10W	KK2	R509			RK73EB2E103J	CHIP R 10K J 1/4W	KK1M1
R365			RK73FB2B2R2J	CHIP R 2.2 J 1/8W	KK2	R510,511			RK73EB2E101J	CHIP R 100 J 1/4W	
R366			RK73GB2A682J	CHIP R 6.8K J 1/10W	KK2	R512,513			RK73GB2A334J	CHIP R 330K J 1/10W	E2E3K2
R367-374			RK73GB2A332J	CHIP R 3.3K J 1/10W	KK2	R512,513			RK73GB2A334J	CHIP R 330K J 1/10W	E4
R375-377			RK73GB2A473J	CHIP R 47K J 1/10W	KK2	R512,513			RK73GB2A334J	CHIP R 330K J 1/10W	KK1M1
R378			RK73GB2A101J	CHIP R 100 J 1/10W	KK2	R514			RK73EB2E101J	CHIP R 100 J 1/4W	
R379			RK73GB2A562J	CHIP R 5.6K J 1/10W	KK2	R515			RK73EB2E102J	CHIP R 1.0K J 1/4W	
R381			RK73GB2A473J	CHIP R 47K J 1/10W	KK2	R516			RK73EB2E472J	CHIP R 4.7K J 1/4W	
R382,383			RK73GB2A102J	CHIP R 1.0K J 1/10W		R517			RK73EB2E102J	CHIP R 1.0K J 1/4W	
R384-389			RK73GB2A101J	CHIP R 100 J 1/10W	KK2	R518,519			RK73GB2A103J	CHIP R 10K J 1/10W	E2E3K2
R390			RK73FB2B100J	CHIP R 10 J 1/8W	KK2	R518,519			RK73GB2A103J	CHIP R 10K J 1/10W	E4
R391,392			RK73GB2A473J	CHIP R 47K J 1/10W	KK2	R518,519			RK73GB2A103J	CHIP R 10K J 1/10W	KK1M1
R393			RK73GB2A101J	CHIP R 100 J 1/10W	KK2	R520			RK73GB2A1R0J	CHIP R 1.0 J 1/10W	E2E3K2
R394-396			RK73FB2B100J	CHIP R 10 J 1/8W	KK2	R520			RK73GB2A1R0J	CHIP R 1.0 J 1/10W	E4
R397			RK73GB2A103J	CHIP R 10K J 1/10W	KK2	R520			RK73GB2A1R0J	CHIP R 1.0 J 1/10W	KK1M1
R398			RK73GB2A473J	CHIP R 47K J 1/10W	KK2	R550			RK73GB2A222J	CHIP R 2.2K J 1/10W	
R404			RK73GB2A223J	CHIP R 22K J 1/10W		R551			RK73GB2A471J	CHIP R 470 J 1/10W	
R405,406			RK73GB2A471J	CHIP R 470 J 1/10W		R552,553			RK73GB2A104J	CHIP R 100K J 1/10W	
R407,408			RK73GB2A472J	CHIP R 4.7K J 1/10W		R554			RK73GB2A471J	CHIP R 470 J 1/10W	
R409			RK73FB2B102J	CHIP R 1.0K J 1/8W		R600,601			RK73GB2A913J	CHIP R 91K J 1/10W	E1E3K2
R410-412			RK73GB2A222J	CHIP R 2.2K J 1/10W	E2E3K2	R600,601			RK73GB2A913J	CHIP R 91K J 1/10W	KK1M1
R410-412			RK73GB2A222J	CHIP R 2.2K J 1/10W	E4	R602			RK73GB2A103J	CHIP R 10K J 1/10W	E1E3K2
R410-412			RK73GB2A222J	CHIP R 2.2K J 1/10W	KK1E1	R602			RK73GB2A103J	CHIP R 10K J 1/10W	KK1M1
R450,451			RK73GB2A102J	CHIP R 1.0K J 1/10W		R603			RK73GB2A470J	CHIP R 47 J 1/10W	E1E3K2
R452			RK73GB2A241J	CHIP R 240 J 1/10W		R603			RK73GB2A470J	CHIP R 47 J 1/10W	KK1M1
R453,454			RK73GB2A102J	CHIP R 1.0K J 1/10W	KK1M1	R604			RK73GB2A274J	CHIP R 270K J 1/10W	E1E3K2
R453,454			RK73GB2A102J	CHIP R 1.0K J 1/10W	K2	R604			RK73GB2A274J	CHIP R 270K J 1/10W	KK1M1
R457			RK73GH2A241D	CHIP R 240 D 1/10W	KK1M1	R605			RK73GB2A563J	CHIP R 56K J 1/10W	E1E3K2
R457			RK73GH2A241D	CHIP R 240 D 1/10W	K2	R605			RK73GB2A563J	CHIP R 56K J 1/10W	KK1M1
R458			RK73GH2A111D	CHIP R 110 D 1/10W	KK1M1	R606			RK73GB2A752J	CHIP R 7.5K J 1/10W	E1E3K2
R458			RK73GH2A111D	CHIP R 110 D 1/10W	K2	R606			RK73GB2A752J	CHIP R 7.5K J 1/10W	KK1M1
R500			RK73GB2A473J	CHIP R 47K J 1/10W	E2E3K2	R607			RK73GB2A470J	CHIP R 47 J 1/10W	E1E3K2

E1 : KDC-W8531 E2 : KDC-W7531Y E3 : KDC-W8531Y E4 : KDC-W7531
 K : KDC-X889 K1 : KDC-X789 K2 : KDC-MP828 M1 : KDC-X8529
 (E : Europe K : North America M : Other Areas W : Without Europe)

△ Indicates safety critical components.

PARTS LIST

ELECTRIC UNIT (X34-3xxx-xx)

Ref. No.	A d d	N e w	Parts No.	Description	Desti- nation	Ref. No.	A d d	N e w	Parts No.	Description	Desti- nation
R607			RK73GB2A470J	CHIP R 47 J 1/10W	KK1M1	R644			RK73GB2A102J	CHIP R 1.0K J 1/10W	
R608			RK73GB2A272J	CHIP R 2.7K J 1/10W	E1E3K2	R655-660			RK73GB2A104J	CHIP R 100K J 1/10W	E1E3K2
R608			RK73GB2A272J	CHIP R 2.7K J 1/10W	KK1M1	R655-660			RK73GB2A104J	CHIP R 100K J 1/10W	KK1M1
R609			RK73GB2A750J	CHIP R 75 J 1/10W	E1E3K2	R700			RK73EB2E472J	CHIP R 4.7K J 1/4W	
R609			RK73GB2A750J	CHIP R 75 J 1/10W	KK1M1	R701			RK73EB2E101J	CHIP R 100 J 1/4W	
R610			RK73GB2A182J	CHIP R 1.8K J 1/10W		R702			RK73EB2E472J	CHIP R 4.7K J 1/4W	
R611			RK73GB2A361J	CHIP R 360 J 1/10W		R703-707			RK73EB2E101J	CHIP R 100 J 1/4W	
R612			RK73GB2A820J	CHIP R 82 J 1/10W	E1E3K2	R708			RK73EB2E100J	CHIP R 10 J 1/4W	
R612			RK73GB2A820J	CHIP R 82 J 1/10W	KK1M1	R709			RK73EB2E4R7J	CHIP R 4.7 J 1/4W	
R613			RK73GB2A123J	CHIP R 12K J 1/10W	E1E3K2	R710			RK73EB2E100J	CHIP R 10 J 1/4W	
R613			RK73GB2A123J	CHIP R 12K J 1/10W	KK1M1	R711			RK73GB2A102J	CHIP R 1.0K J 1/10W	
R614			RK73GB2A103J	CHIP R 10K J 1/10W	E1E3K2	R712			RK73EB2E102J	CHIP R 1.0K J 1/4W	E2E3K2
R614			RK73GB2A103J	CHIP R 10K J 1/10W	KK1M1	R712			RK73EB2E102J	CHIP R 1.0K J 1/4W	E4
R615			RK73GB2A223J	CHIP R 22K J 1/10W		R712			RK73EB2E102J	CHIP R 1.0K J 1/4W	KK1E1
R616			RK73GB2A103J	CHIP R 10K J 1/10W	E1E3K2	R713-715			RK73EB2E471J	CHIP R 470 J 1/4W	E2E3K2
R616			RK73GB2A103J	CHIP R 10K J 1/10W	KK1M1	R713-715			RK73EB2E471J	CHIP R 470 J 1/4W	E4
R617			RK73GB2A223J	CHIP R 22K J 1/10W		R713-715			RK73EB2E471J	CHIP R 470 J 1/4W	KK1E1
R618		*	RK73GB2A820J	CHIP R 82 J 1/10W	E1E3K2	R750			RK73GB2A683J	CHIP R 68K J 1/10W	
R618		*	RK73GB2A820J	CHIP R 82 J 1/10W	KK1M1	R752			RK73GB2A102J	CHIP R 1.0K J 1/10W	
R619			RK73GB2A123J	CHIP R 12K J 1/10W	E1E3K2	R753			RK73GB2A473J	CHIP R 47K J 1/10W	
R619			RK73GB2A123J	CHIP R 12K J 1/10W	KK1M1	R755-758			RK73GB2A471J	CHIP R 470 J 1/10W	
R620,621			RK73GB2A361J	CHIP R 360 J 1/10W		R759-762			RK73GB2A103J	CHIP R 10K J 1/10W	
R622		*	RK73GB2A820J	CHIP R 82 J 1/10W	E1E3K2	R763			RK73GB2A100J	CHIP R 10 J 1/10W	
R622		*	RK73GB2A820J	CHIP R 82 J 1/10W	KK1M1	R764			RK73GB2A103J	CHIP R 10K J 1/10W	
R623			RK73GB2A123J	CHIP R 12K J 1/10W	E1E3K2	R765			RK73GB2A432J	CHIP R 4.3K J 1/10W	
R623			RK73GB2A123J	CHIP R 12K J 1/10W	KK1M1	R766			RK73GB2A431J	CHIP R 430 J 1/10W	
R624			RK73GB2A103J	CHIP R 10K J 1/10W	E1E3K2	R767			RK73GB2A390J	CHIP R 39 J 1/10W	
R624			RK73GB2A103J	CHIP R 10K J 1/10W	KK1M1	R768			RK73GB2A223J	CHIP R 22K J 1/10W	
R625			RK73GB2A223J	CHIP R 22K J 1/10W		R770			RK73GB2A133J	CHIP R 13K J 1/10W	
R626			RK73GB2A103J	CHIP R 10K J 1/10W	E1E3K2	R771			RK73GB2A223J	CHIP R 22K J 1/10W	
R626			RK73GB2A103J	CHIP R 10K J 1/10W	KK1M1	R772			RK73GB2A221J	CHIP R 220 J 1/10W	
R627			RK73GB2A223J	CHIP R 22K J 1/10W		R800			RK73GB2A391J	CHIP R 390 J 1/10W	
R628		*	RK73GB2A820J	CHIP R 82 J 1/10W	E1E3K2	R801			RK73GB2A242J	CHIP R 2.4K J 1/10W	
R628		*	RK73GB2A820J	CHIP R 82 J 1/10W	KK1M1	R803			RK73GH2A512D	CHIP R 5.1K D 1/10W	
R629			RK73GB2A123J	CHIP R 12K J 1/10W	E1E3K2	R804			RK73GH2A472D	CHIP R 4.7K D 1/10W	
R629			RK73GB2A123J	CHIP R 12K J 1/10W	KK1M1	R805,806			RK73GB2A102J	CHIP R 1.0K J 1/10W	
R630,631			RK73GB2A361J	CHIP R 360 J 1/10W		R807			RK73GB2A103J	CHIP R 10K J 1/10W	
R632			RK73GB2A820J	CHIP R 82 J 1/10W	E1E3K2	R808			RK73GB2A113J	CHIP R 11K J 1/10W	
R632			RK73GB2A820J	CHIP R 82 J 1/10W	KK1M1	R809			RK73GB2A101J	CHIP R 100 J 1/10W	
R633			RK73GB2A123J	CHIP R 12K J 1/10W	E1E3K2	R810			RK73FB2B152J	CHIP R 1.5K J 1/8W	
R633			RK73GB2A123J	CHIP R 12K J 1/10W	KK1M1	R811			RK73GB2A104J	CHIP R 100K J 1/10W	
R634			RK73GB2A103J	CHIP R 10K J 1/10W	E1E3K2	R812			RK73FB2B4R7J	CHIP R 4.7 J 1/8W	
R634			RK73GB2A103J	CHIP R 10K J 1/10W	KK1M1	R813			RK73GB2A332J	CHIP R 3.3K J 1/10W	
R635			RK73GB2A223J	CHIP R 22K J 1/10W		R814,815			RK73GB2A101J	CHIP R 100 J 1/10W	
R636			RK73GB2A103J	CHIP R 10K J 1/10W	E1E3K2	R817			RK73GB2A100J	CHIP R 10 J 1/10W	
R636			RK73GB2A103J	CHIP R 10K J 1/10W	KK1M1	R818			RK73GB2A8R2J	CHIP R 8.2 J 1/10W	
R637			RK73GB2A223J	CHIP R 22K J 1/10W		R819-822			RK73GB2A9R1J	CHIP R 9.1 J 1/10W	
R638		*	RK73GB2A820J	CHIP R 82 J 1/10W	E1E3K2	R823			RK73FB2B1R0J	CHIP R 1.0 J 1/8W	
R638		*	RK73GB2A820J	CHIP R 82 J 1/10W	KK1M1	W201			R92-1252-05	CHIP R 0 OHM J 1/16W	E1E2E3
R639			RK73GB2A123J	CHIP R 12K J 1/10W	E1E3K2	W201			R92-1252-05	CHIP R 0 OHM J 1/16W	E4
R639			RK73GB2A123J	CHIP R 12K J 1/10W	KK1M1	W603,604			R92-1252-05	CHIP R 0 OHM J 1/16W	E2E4
R640			RK73GB2A361J	CHIP R 360 J 1/10W		W607-616			R92-1252-05	CHIP R 0 OHM J 1/16W	E2E4
R641			RK73EB2E100J	CHIP R 10 J 1/4W		W751			R92-1252-05	CHIP R 0 OHM J 1/16W	
R642			RK73EB2E4R7J	CHIP R 4.7 J 1/4W		S1,2			S68-0886-05	PUSH SWITCH	
R643			RK73EB2E100J	CHIP R 10 J 1/4W							

E1 : KDC-W8531 E2 : KDC-W7531Y E3 : KDC-W8531Y E4 : KDC-W7531
K : KDC-X889 K1 : KDC-X789 K2 : KDC-MP828 M1 : KDC-X8529

50 (E : Europe K : North America M : Other Areas W : Without Europe)

△ Indicates safety critical components.

PARTS LIST

ELECTRIC UNIT (X34-3xxx-xx)

Ref. No.	Add	New	Parts No.	Description	Destination	Ref. No.	Add	New	Parts No.	Description	Destination
D1			S2V60*A	DIODE		D750-753			D1F60-5063	DIODE	
D20			RB160L-40	DIODE		D750-753			1SR154-400	DIODE	
D21			UDZS5.6B	ZENER DIODE		D754,755			DAP222	DIODE	
D30			HZU9.1(B1)-E	ZENER DIODE		D754,755	*		KDS120E-P	DIODE	
D31			UDZS8.2B	ZENER DIODE		D756-759			D1F60-5063	DIODE	
D40			UDZS5.6B	ZENER DIODE		D756-759			1SR154-400	DIODE	
D41			HZU11(B1)-E	ZENER DIODE		D800			UDZS6.8B	ZENER DIODE	
D41		*	02DZ11F-Y	ZENER DIODE		D801			DA227	DIODE	
D50		*	HZU16(B1)-E	ZENER DIODE		D802			UDZS16B	ZENER DIODE	
D60,61			SFPB-54VNF	DIODE		IC1	*		XC6204B332MR	ANALOGUE IC	KK2
D80-82			RB060L-40	DIODE		IC3,4	*		NJM2864F05-ZB	ANALOGUE IC	KK2
D101			DA227	DIODE		IC5	*		XC6204B332MR	ANALOGUE IC	KK2
D102-104			DAP222	DIODE		IC10			M5237ML-CF0J	ANALOGUE IC	
D102-104		*	KDS120E-P	DIODE		IC60	*		FA3687V	ANALOGUE IC	
D200,201			DAP202U	DIODE		IC80	*		LT3467A	ANALOGUE IC	
D200,201			KDS120-P	DIODE		IC100			S-80836CNNB-J	MOS-IC	
D200,201			MC2846	DIODE		IC102	*		30625MGPA34GP	MICROCONTROLLER IC	E2E3E4
D202			UDZS6.2B	ZENER DIODE		IC102	*		30625MGPA34GP	MICROCONTROLLER IC	K1M1E1
D202			02DZ6.2F-Y	ZENER DIODE		IC102	*		30625MWPA33GP	MICROCONTROLLER IC	KK2
D203			UDZS6.8B	ZENER DIODE		IC103			TC7W02FU-F	MOS-IC	
D204			DAP202U	DIODE		IC104			BR24L04FV-W	ROM IC	
D204			KDS120-P	DIODE		IC200	*		TPD1018F-F	ANALOGUE IC	
D204			MC2846	DIODE		IC300			E-TDA7415	ANALOGUE IC	
D205			UDZS6.8B	ZENER DIODE		IC301,302	*		RC4580IDR	ANALOGUE IC	KK2
D206			UDZS4.7B	ZENER DIODE		IC303	*		AK7730A	MOS-IC	KK2
D207			UDZS5.6B	ZENER DIODE	E1E2E3	IC304			TC74HC4050AFT	MOS-IC	KK2
D207			UDZS5.6B	ZENER DIODE	E4	IC305	*		AK4359VF	MOS-IC	KK2
D207			UDZS5.6B	ZENER DIODE	KK1M1	IC306-308	*		RC4580IDR	ANALOGUE IC	KK2
D207			02DZ5.6F-Y	ZENER DIODE	E1E2E3	IC400			E-TDA7479AD	ANALOGUE IC	E2E3K2
D207			02DZ5.6F-Y	ZENER DIODE	E4	IC400			E-TDA7479AD	ANALOGUE IC	E4
D207			02DZ5.6F-Y	ZENER DIODE	KK1M1	IC400			E-TDA7479AD	ANALOGUE IC	KK1E1
D208-213			D1F60-5063	DIODE		IC450			LB1930M-E	ANALOGUE IC	
D208-213			1SR154-400	DIODE		IC451	*		MMA6261QR2	ANALOGUE IC	KK1M1
D300			DA204U	DIODE	KK2	IC451	*		MMA6261QR2	ANALOGUE IC	K2
D401			IMSA-6801-E	SURGE ABSORBER		IC500	*		RC4580IDR	ANALOGUE IC	E2E3K2
D500			DA204K	DIODE		IC500	*		RC4580IDR	ANALOGUE IC	E4
D501			STZ6.2N	ZENER DIODE		IC500	*		RC4580IDR	ANALOGUE IC	KM1E1
D502			DA204K	DIODE		IC600	*		ICL7660SIBAZ	ANALOGUE IC	E1E3K2
D503			STZ6.2N	ZENER DIODE		IC600	*		ICL7660SIBAZ	ANALOGUE IC	KK1M1
D504			DA204U	DIODE	E2E3K2	IC601-603			NJM4565V-ZB	ANALOGUE IC	E1E3K2
D504			DA204U	DIODE	E4	IC601-603			NJM4565V-ZB	ANALOGUE IC	KK1M1
D504			DA204U	DIODE	KM1E1	IC750			E-TDA7560A	ANALOGUE IC	
D505			DAP202U	DIODE		IC800			RC4580IDR	ANALOGUE IC	
D505			KDS120-P	DIODE		Q10			2SB1565	TRANSISTOR	
D505			MC2846	DIODE		Q11,12			UMC2N	TRANSISTOR	
D506			STZ6.2N	ZENER DIODE		Q20			2SB1565	TRANSISTOR	
D600			UDZS5.6B	ZENER DIODE	E1E3K2	Q21			2SD2351(W)	TRANSISTOR	
D600			UDZS5.6B	ZENER DIODE	KK1M1	Q22			2SA1577	TRANSISTOR	
D601			UDZS11B	ZENER DIODE	E1E3K2	Q23			DTC124EUA	DIGITAL TRANSISTOR	
D601			UDZS11B	ZENER DIODE	KK1M1	Q23			KRC403-P	DIGITAL TRANSISTOR	
D608,609			STZ6.8N	ZENER DIODE		Q23			RT1N241M	DIGITAL TRANSISTOR	
D700-702			STZ6.2N	ZENER DIODE		Q30			2SB1565	TRANSISTOR	
D703,704			STZ6.8N	ZENER DIODE		Q31			2SB1184	TRANSISTOR	
D705,706			STZ6.2N	ZENER DIODE	E1E2E3	Q32,33			2SC4081	TRANSISTOR	
D705,706			STZ6.2N	ZENER DIODE	E4	Q40			2SB1565	TRANSISTOR	

E1 : KDC-W8531 E2 : KDC-W7531Y E3 : KDC-W8531Y E4 : KDC-W7531
K : KDC-X889 K1 : KDC-X789 K2 : KDC-MP828 M1 : KDC-X8529
(E : Europe K : North America M : Other Areas W : Without Europe)

△ Indicates safety critical components.

PARTS LIST

ELECTRIC UNIT (X34-3xxx-xx)

Ref. No.	A d d	N e w	Parts No.	Description	Desti- nation
Q41			2SB1443	TRANSISTOR	
Q42			UMD12N	TRANSISTOR	
Q43			UMC2N	TRANSISTOR	
Q44			2SC4081	TRANSISTOR	
Q45			2SD2351(W)	TRANSISTOR	
Q50		*	2SB1449(R)-E	TRANSISTOR	
Q51			UMC2N	TRANSISTOR	
Q52			2SC4081	TRANSISTOR	
Q60			DTC143TUA	DIGITAL TRANSISTOR	
Q60			KRC410-P	DIGITAL TRANSISTOR	
Q60			RT1N430M	DIGITAL TRANSISTOR	
Q61			UMG2N	TRANSISTOR	
Q62			DTA143TUA	DIGITAL TRANSISTOR	
Q63,64		*	2SJ484-E	FET	
Q80			2SB1188(R)	TRANSISTOR	
Q81			2SC4081	TRANSISTOR	
Q91			2SD2351(W)	TRANSISTOR	
Q100			2SA1576A	TRANSISTOR	
Q101			DTC144EUA	DIGITAL TRANSISTOR	
Q101			KRC404-P	DIGITAL TRANSISTOR	
Q101			RT1N441M	DIGITAL TRANSISTOR	
Q200,201			DTA124EUA	DIGITAL TRANSISTOR	
Q200,201			KRA303-P	DIGITAL TRANSISTOR	
Q200,201			RT1P241M	DIGITAL TRANSISTOR	
Q202			2SC4081	TRANSISTOR	
Q203			2SA1576A	TRANSISTOR	
Q204,205			2SC4081	TRANSISTOR	
Q206			DTA123JK	DIGITAL TRANSISTOR	E1E2E3
Q206			DTA123JK	DIGITAL TRANSISTOR	E4
Q206			DTA123JK	DIGITAL TRANSISTOR	KK1M1
Q207			DTC144EUA	DIGITAL TRANSISTOR	
Q207			KRC404-P	DIGITAL TRANSISTOR	
Q207			RT1N441M	DIGITAL TRANSISTOR	
Q208			2SB1188(Q,R)	TRANSISTOR	KK1M1
Q208			2SB1188(Q,R)	TRANSISTOR	K2
Q209			DTC114YUA	DIGITAL TRANSISTOR	KK1M1
Q209			DTC114YUA	DIGITAL TRANSISTOR	K2
Q209			KRC407-P	DIGITAL TRANSISTOR	KK1M1
Q209			KRC407-P	DIGITAL TRANSISTOR	K2
Q209			RT1N144M	DIGITAL TRANSISTOR	KK1M1
Q209			RT1N144M	DIGITAL TRANSISTOR	K2
Q300			DTA114EUA	DIGITAL TRANSISTOR	KK2
Q300			KRA302-P	DIGITAL TRANSISTOR	KK2
Q300			RT1P141M	DIGITAL TRANSISTOR	KK2
Q402			2SB1689	TRANSISTOR	
Q403			DTC124EUA	DIGITAL TRANSISTOR	
Q403			KRC403-P	DIGITAL TRANSISTOR	
Q403			RT1N241M	DIGITAL TRANSISTOR	
Q450			DTC114YUA	DIGITAL TRANSISTOR	
Q450			KRC407-P	DIGITAL TRANSISTOR	
Q450			RT1N144M	DIGITAL TRANSISTOR	
Q500			2SC4617	TRANSISTOR	E2E3K2
Q500			2SC4617	TRANSISTOR	E4
Q500			2SC4617	TRANSISTOR	KM1E1
Q600			2SC4617	TRANSISTOR	E1E3K2

Ref. No.	A d d	N e w	Parts No.	Description	Desti- nation
Q600			2SC4617	TRANSISTOR	KK1M1
Q601			2SA1774	TRANSISTOR	E1E3K2
Q601			2SA1774	TRANSISTOR	KK1M1
Q602			2SC4617	TRANSISTOR	E1E3K2
Q602			2SC4617	TRANSISTOR	KK1M1
Q603			2SA1576A	TRANSISTOR	E1E3K2
Q603			2SA1576A	TRANSISTOR	KK1M1
Q604			2SC4081	TRANSISTOR	E1E3K2
Q604			2SC4081	TRANSISTOR	KK1M1
Q605			2SA1576A	TRANSISTOR	E1E3K2
Q605			2SA1576A	TRANSISTOR	KK1M1
Q606			2SC4081	TRANSISTOR	E1E3K2
Q606			2SC4081	TRANSISTOR	KK1M1
Q607			2SB1443	TRANSISTOR	E1E3K2
Q607			2SB1443	TRANSISTOR	KK1M1
Q608-613			DTC143TUA	DIGITAL TRANSISTOR	
Q608-613			KRC410-P	DIGITAL TRANSISTOR	
Q608-613			RT1N430M	DIGITAL TRANSISTOR	
Q800			DTA124EUA	DIGITAL TRANSISTOR	
Q800			KRA303-P	DIGITAL TRANSISTOR	
Q800			RT1P241M	DIGITAL TRANSISTOR	
Q801			2SA1774	TRANSISTOR	
Q802			2SC2873-F	TRANSISTOR	
TH750			PRF21BE471QB2	POSITIVE RESISTOR	
A1	2D		X86-3840-11	FRONT-END UNIT	KK1M1
A1	2D		X86-3840-11	FRONT-END UNIT	K2
A1	2D	*	X86-3842-70	FRONT-END UNIT	E1E2E3
A1	2D		X86-3842-71	FRONT-END UNIT	E4
MECHANISM ASSY (X92-5100-00)					
2	1B		A10-4827-32	CHASSIS	
5	1B		D10-4576-83	ARM ASSY	
8	2A		D10-4579-23	LEVER ASSY	
10	2A		D10-4581-13	ARM	
11	2A		D10-4582-13	ARM	
12	3A		D10-4583-03	ARM	
13	3A		D10-4584-03	ARM	
14	3B		D10-4585-03	ARM	
15	2A		D10-4586-13	SLIDER	
16	3B		D10-4587-52	SLIDER	
17	2B		D10-4588-13	SLIDER	
18	2B		D10-4595-04	ARM	
19	2B		D10-4596-24	ARM	
22	2A		D13-2151-04	GEAR	
23	2B		D13-2152-04	GEAR	
24	3B		D13-2153-04	GEAR	
25	3B		D13-2154-04	GEAR	
26	3B		D13-2155-04	WORM	
27	2B		D13-2156-14	GEAR	
28	3B		D13-2157-04	GEAR	
29	2B		D13-2158-04	GEAR	
30	2B		D13-2168-04	GEAR	
31	3B		D13-2171-04	GEAR	
32	1B		D13-2172-13	RACK (GEAR)	
33	2A		D14-0759-04	ROLLER	

E1 : KDC-W8531 E2 : KDC-W7531Y E3 : KDC-W8531Y E4 : KDC-W7531

K : KDC-X889 K1 : KDC-X789 K2 : KDC-MP828 M1 : KDC-X8529

52 (E : Europe K : North America M : Other Areas W : Without Europe)

△ Indicates safety critical components.

PARTS LIST

MECHANISM ASSY (X92-5100-00)

Ref. No.	Add	New	Parts No.	Description	Destination	Ref. No.	Add	New	Parts No.	Description	Destination
35	2B		D21-2382-04	SHAFT							
36	1A		D23-0954-04	RETAINER							
37	1B		D39-0246-05	DAMPER							
38	2B		G01-3072-04	EXTENSION SPRING							
39	2A		G01-3073-04	TORSION COIL SPRING							
40	2A		G01-3074-04	EXTENSION SPRING							
41	1B		G01-3075-14	EXTENSION SPRING							
42	2A		G01-3076-04	EXTENSION SPRING							
43	1B		G01-3077-14	EXTENSION SPRING							
44	2B		G02-1399-04	FLAT SPRING							
45	2B		G02-1408-04	FLAT SPRING							
51	1A		J21-9676-32	MOUNTING HARDWARE							
52	3B		J21-9677-22	MOUNTING HARDWARE							
53	1B		J21-9678-13	MOUNTING HARDWARE							
55	1A		J90-1001-11	GUIDE							
56	1B		J90-1023-03	GUIDE							
DFPC1	3A		J84-0141-05	FLEXIBLE PRINTED WIRING BOARD							
A	2B		N09-4460-05	TAPTITE SCREW (OVAL P TAPTIT)							
B	1B		N09-4472-15	MACHINE SCREW (M1.7X8.0)							
C	2B		N09-6004-05	MACHINE SCREW (M1.7X2.5 IB-L)							
E	2B		N09-6007-05	MACHINE SCREW (PAN M2X2)							
F	1A		N09-6051-05	TAPTITE SCREW (BIND P 2X5)							
G	2A		N19-2163-04	FLAT WASHER							
H	1B		N39-2020-46	PAN HEAD MACHINE SCREW							
J	1B		N09-6108-05	MACHINE SCREW (M2*3.5)							
K	3B		N09-6155-05	SEMS (TAPTITE SCREW) (PT2X6)							
DM1	3B		T42-1066-04	DC MOTOR (SPINDLE)							
DM2	2B		T42-1067-04	DC MOTOR (LOADING)							
DPU1	2B		X93-2010-00	OPTICAL PICKUP ASSY							

E1 : KDC-W8531 E2 : KDC-W7531Y E3 : KDC-W8531Y E4 : KDC-W7531
 K : KDC-X889 K1 : KDC-X789 K2 : KDC-MP828 M1 : KDC-X8529
 (E : Europe K : North America M : Other Areas W : Without Europe)

△ Indicates safety critical components.

SPECIFICATIONS

FM	Total Harmonic Distortion
Frequency Range (Frequency step)	KDC-MP828 0.01% (1kHz)
KDC-MP828/X889/X789 87.9MHz~107.9MHz (200kHz)	KDC-X889/X789/X8529/W7531/W7531Y/W8531/W8531Y
KDC-X8529 87.5MHz~108.0MHz (50kHz) 0.008% (1kHz)
..... 87.9MHz~107.9MHz (200kHz)	S/N Ratio 110dB (1kHz)
KDC-W7531/W7531Y/W8531/W8531Y	Dynamic Range 93dB
..... 87.5MHz~108.0MHz (50kHz)	Channel Separation 96dB
Channel Space Selection	MP3 Decode Compliant with MPEG-1/2 Audio Layer-3
KDC-MP828/X889/X789/X8529 50kHz/200kHz	WMA Decode Compliant with Windows Media Audio
Usable Sensitivity (S/N : 30dB)	AAC Decode AAC-LC “.m4a” files
KDC-MP828/X889/X789/X8529 9.3dBf (0.8μV/75Ω)	
Usable Sensitivity (S/N : 26dB)	Preout Level / Load
KDC-W7531/W7531Y/W8531/W8531Y 0.7μV/75Ω	KDC-MP828 5000mV/10kΩ
Quieting Sensitivity (S/N : 50dB)	KDC-X889/X789/X8529/W7531/W7531Y/W8531/W8531Y
KDC-MP828/X889/X789/X8529 15.2dBf (1.6μV/75Ω) 5000mV/10kΩ (CD/CD-CH)
Quieting Sensitivity (S/N : 46dB)	Preout Impedance ≤80Ω
KDC-W7531/W7531Y/W8531/W8531Y 1.6μV/75Ω	
Frequency Response (±3.0dB) 30Hz~15kHz	AUX input
S/N	Frequency Response 20Hz~20kHz (±1dB)
KDC-MP828/X889/X789/X8529 70dB (MONO)	Input Maximum Voltage 1200mV
KDC-W7531/W7531Y/W8531/W8531Y 65dB (MONO)	Input Impedance 100k
Selectivity ≥80dB (±400kHz)	
Stereo Separation	Amplifier
KDC-MP828/X889/X789/X8529 40dB (1kHz)	Maximum Power 50W x 4
KDC-W7531/W7531Y/W8531/W8531Y 35dB (1kHz)	Full Bandwidth Power (at less than 1% THD)
	KDC-MP828/X889/X789/X8529 22W x 4
AM (MW)	Power (DIN45324, +B=14.4V)
Frequency Range (Frequency step)	KDC-W7531/W7531Y/W8531/W8531Y 30W x 4
KDC-MP828/X889/X789 530kHz~1700kHz (10kHz)	
KDC-X8529 531kHz~1611kHz (9kHz)	Tone (KDC-MP828/X889)
..... 530kHz~1700kHz (10kHz)	Babd 1 60Hz~200kHz (±9dB)
KDC-W7531/W7531Y/W8531/W8531Y	Band 2 250Hz~1kHz (±9dB)
..... 531kHz~1611kHz (9kHz)	Band 3 1.25kHz~4kHz (±9dB)
Channel Space Selection	Band 4 5kHz~16kHz (±9dB)
KDC-MP828/X889/X789/X8529 9kHz/10kHz	
Usable Sensitivity (S/N : 20dB)	Tone (KDC-X789/X8529/W7531/W7531Y/W8531/W8531Y)
KDC-MP828/X889/X789/X8529 28dBμ (25μV)	Bass 100Hz±10dB
KDC-W7531/W7531Y/W8531/W8531Y 25μV	Middle 1kHz±10dB
	Treble 10kHz±10dB
LW (KDC-W7531/W7531Y/W8531/W8531Y)	
Frequency Range 153kHz~281kHz	General
Usable Sensitivity (S/N : 20dB) 45μV	Operating Voltage (11~16V allowable) 14.4V
	Current Consumption 10A
CD	Installation Size (W x H x D)
Laser Diode GaAlAs 182 x 53 x 155mm (7-3/16 x 2-1/16 x 6-1/10 inch)
Digital Filter (D/A) 8 Times Over Sampling	Weight 1.50kHz (3.31lbs)
D/A Converter 1Bit	
Spindle Speed (Audio files) 1000~400rpm (CLV. 2 times)	KENWOOD follows a policy of continuous advancements
Wow & Flutter Below Measurable Limit	in development.
Frequency Response 10Hz~20kHz (±1dB)	For this reason specifications may be changed without notice.

